

組別: 3男單 預賽
組數: 72 小組3取1、4取2
晉級: 24

9月9日

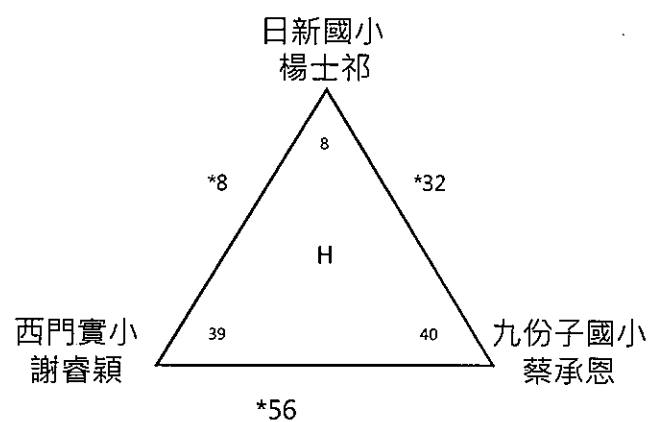
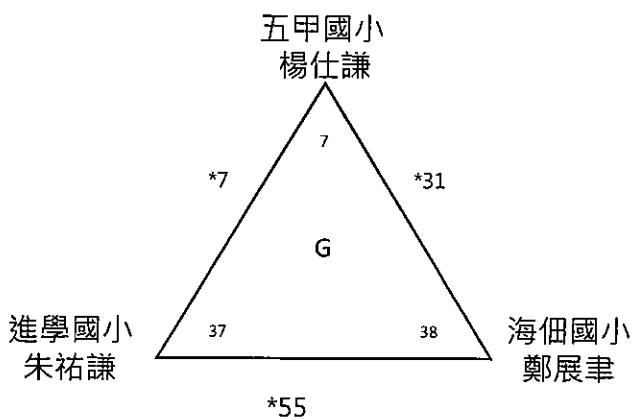
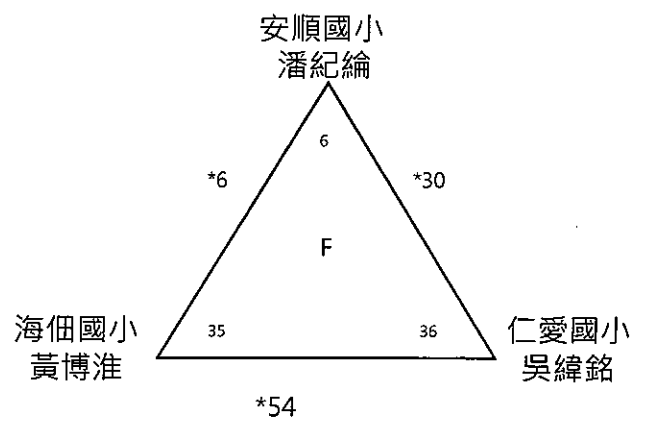
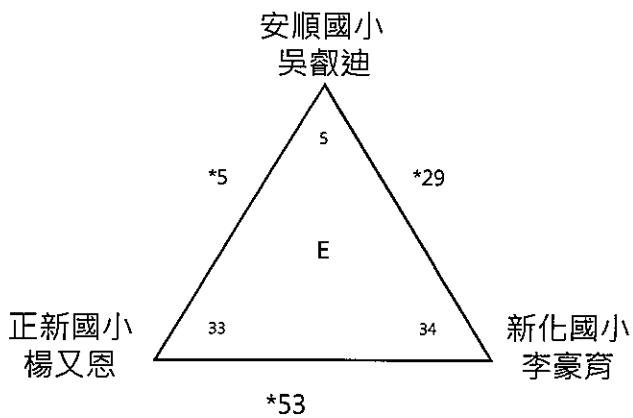
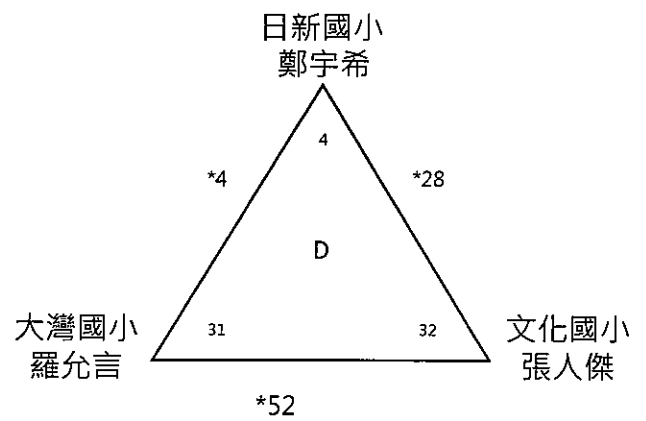
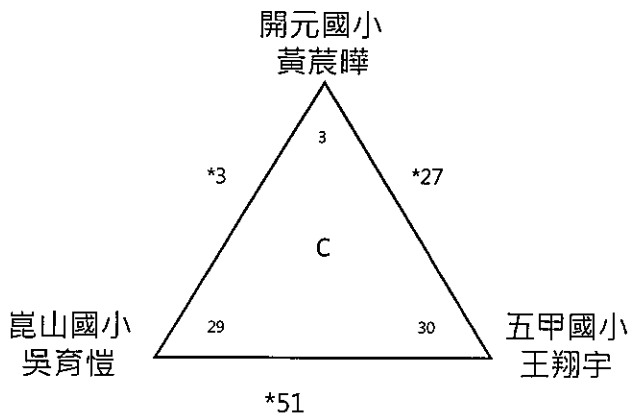
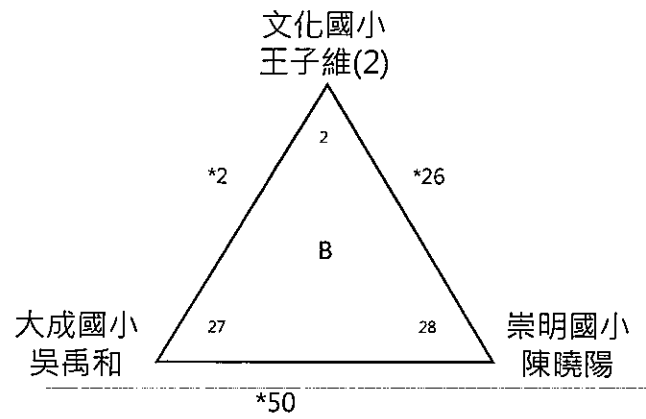
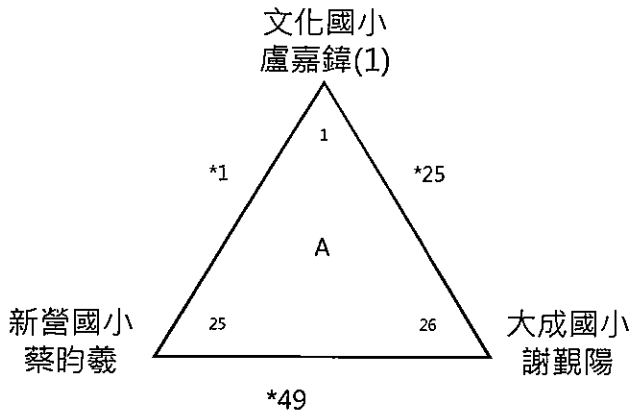

組別: 3男單 預賽
組數: 72 小組3取1、4取2
晉級: 24

9月9日

崑山國小
林詠宸

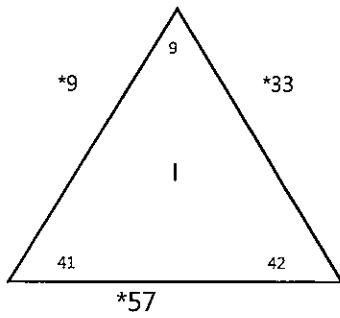

正新國小
陳宣宇

新化國小
顏璿恩

永華國小
辛堉淳

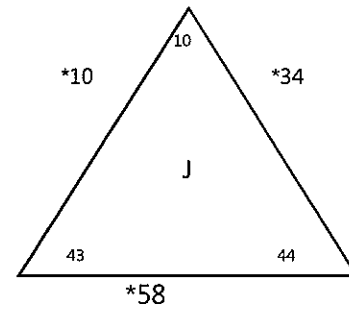

大成國小
楊皓喆

大灣國小
楊于立

億載國小
呂允程

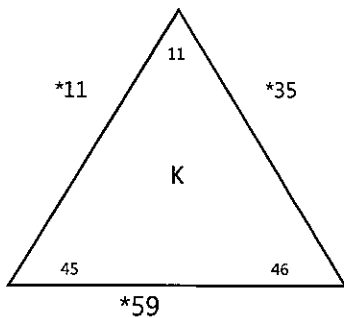

開元國小
王培淮

崑山國小
吳存恩

五王國小
陳冠銘

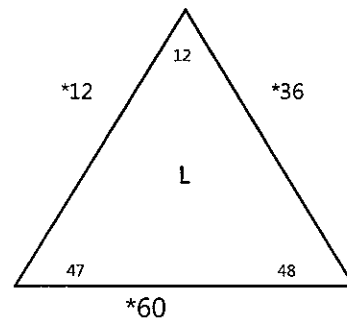

立人國小
李承陽

永華國小
謝元勝

文化國小
陳郁安

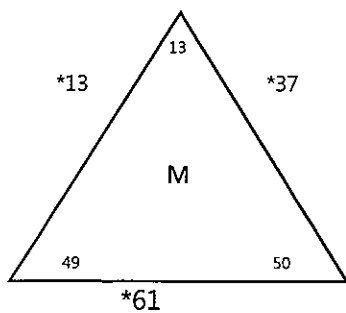

德高國小
達里歐

大灣國小
鄭恩廷

仁愛國小
陳亮維

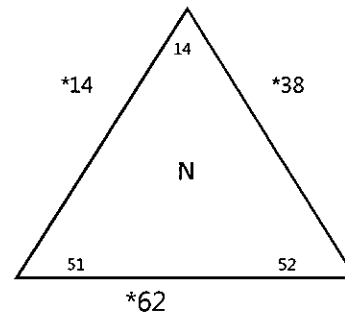

崑山國小
陳祐濬

日新國小
林柏伸

五甲國小
林品澤

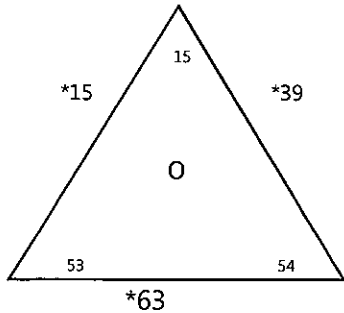

崇學國小
王晨碩

新化國小
黃子譚

崇學國小
吳恩宇

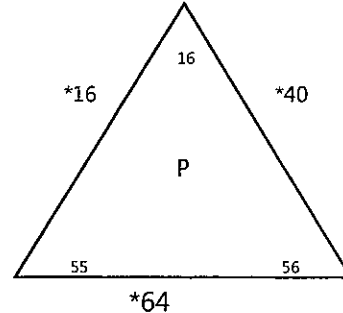

裕文國小
鄭濟文

海佃國小
吳宥翔

組別: 3男單 預賽
組數: 72 小組3取1、4取2
晉級: 24

9月9日

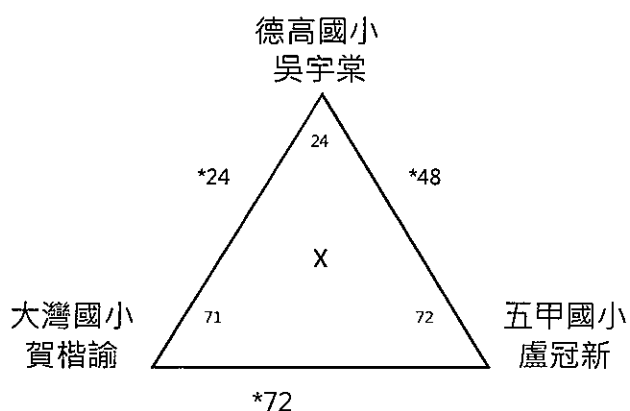
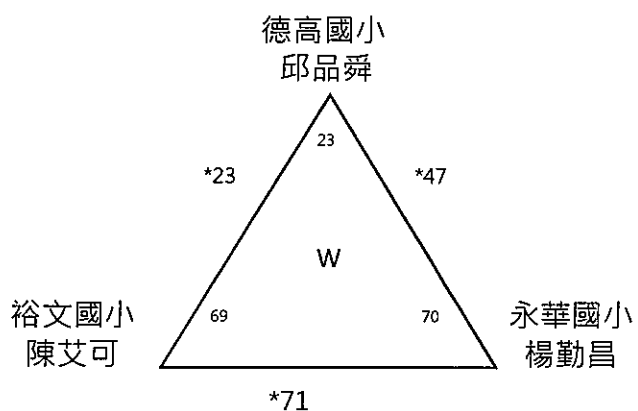
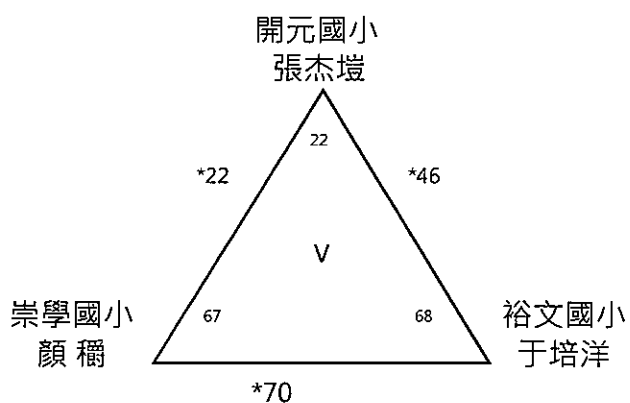
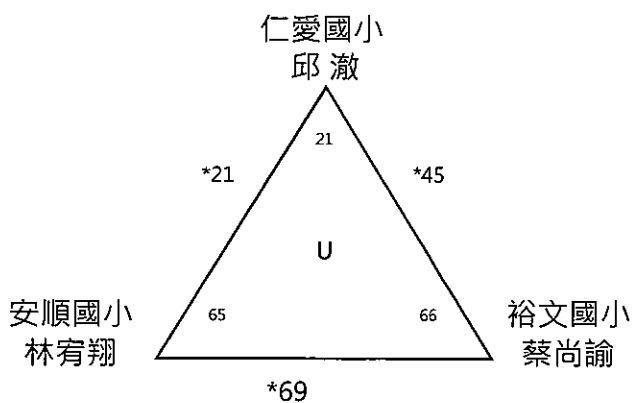
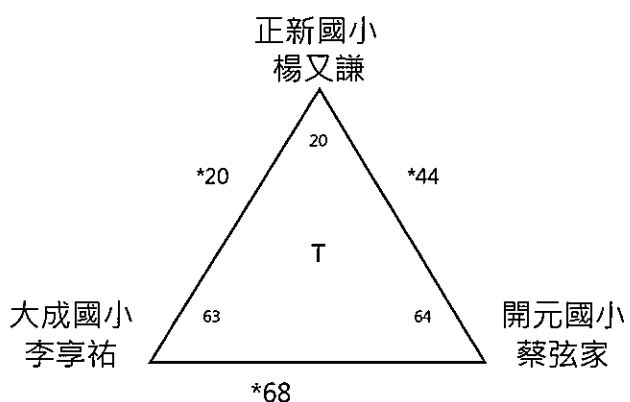
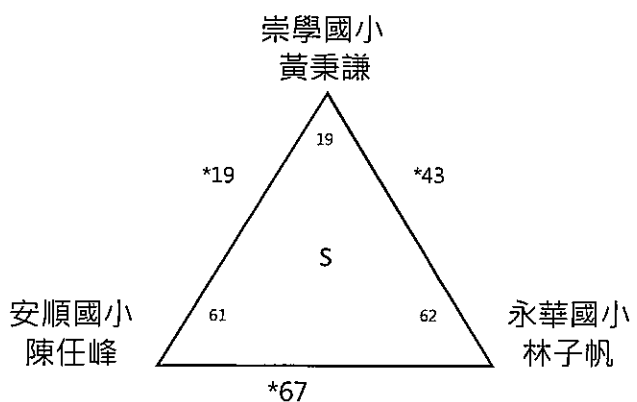
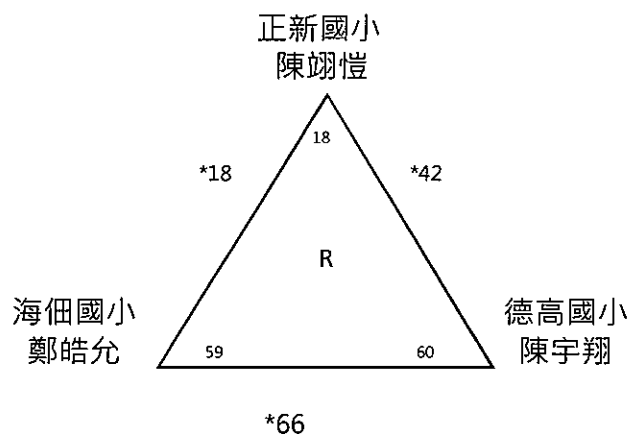
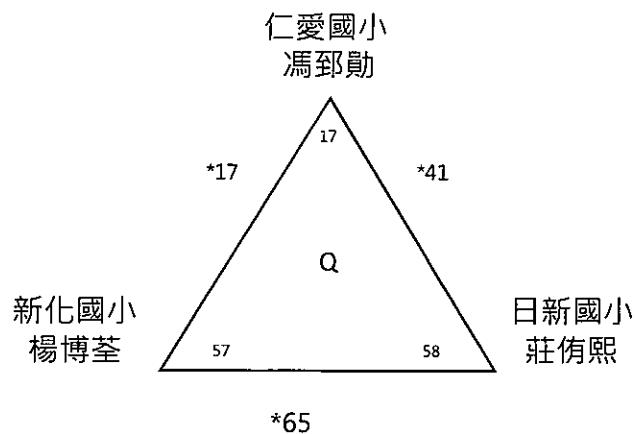

組別: 3男單決
 決賽: 24組
 名次: 取八名

9月10日

籤號 種子

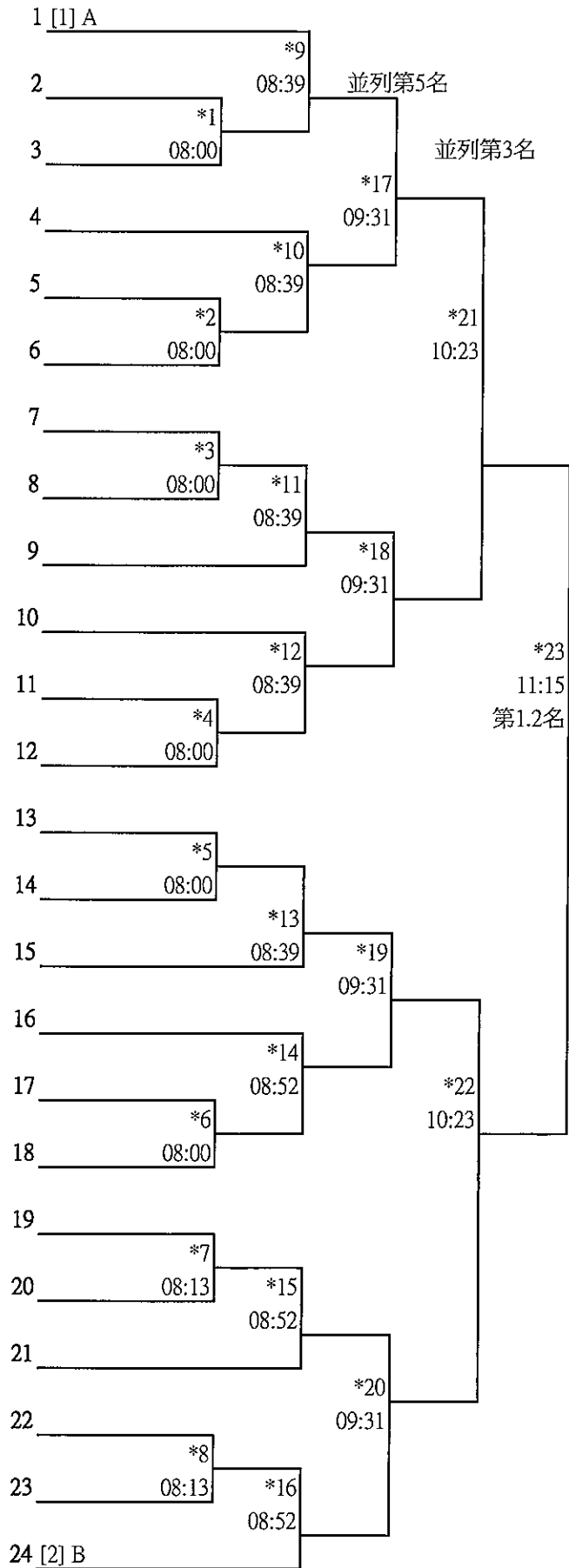

組別: 4男單 預賽

組數: 65 小組3取1、4取2

9月9日

晉級: 23

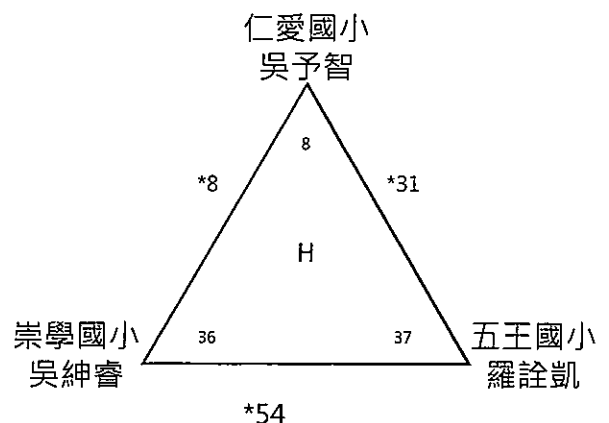
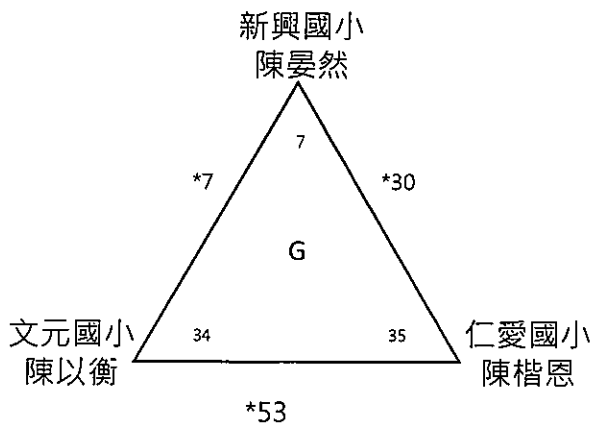
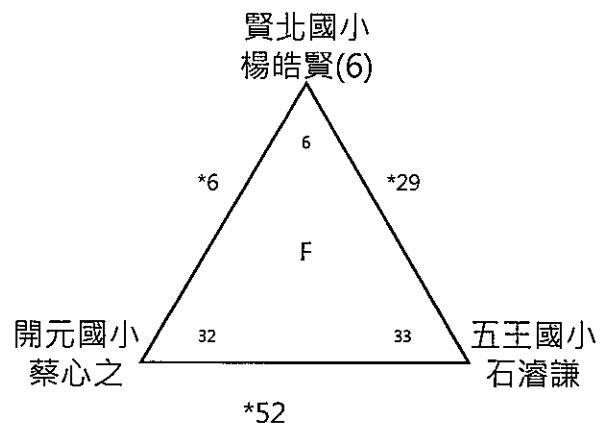
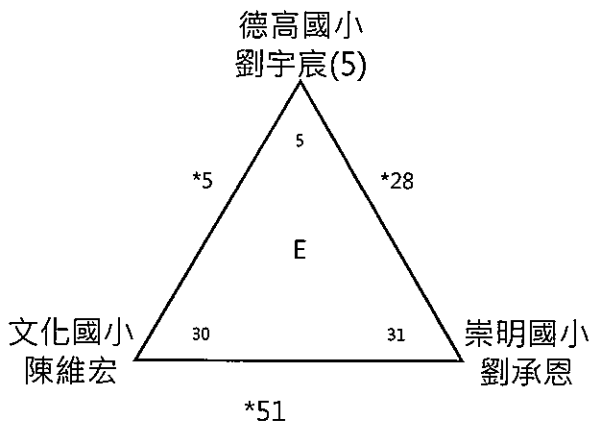
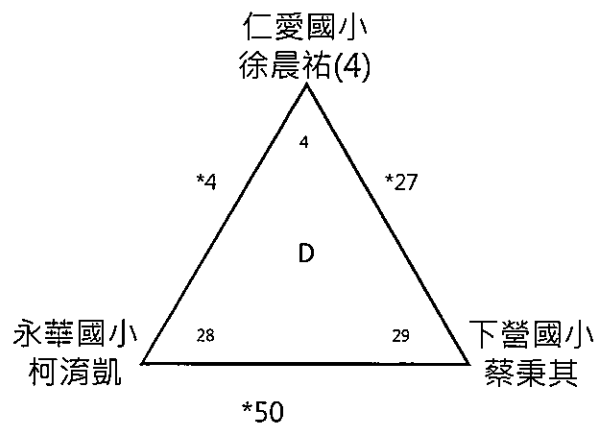
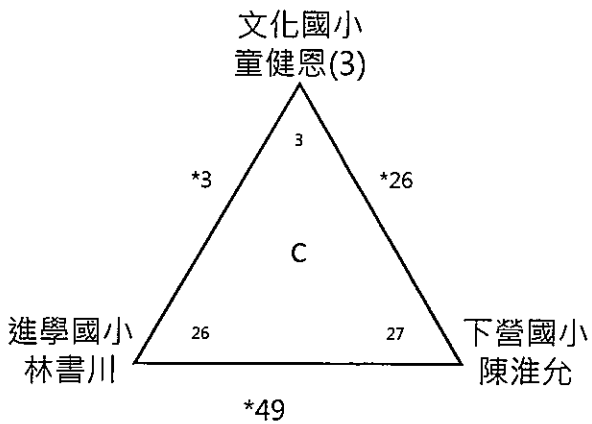
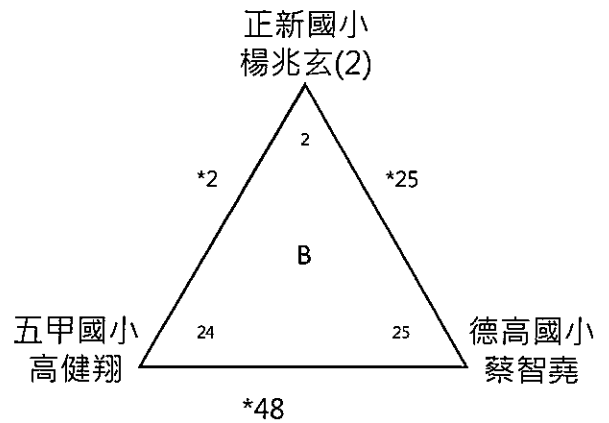
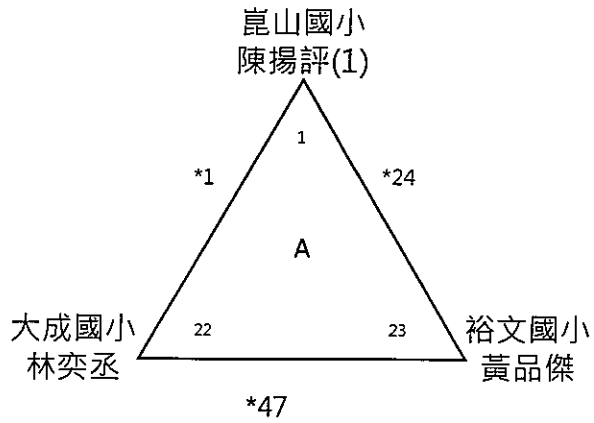

組別: 4男單 預賽
 組數: 65 小組3取1、4取2
 晉級: 23

9月9日

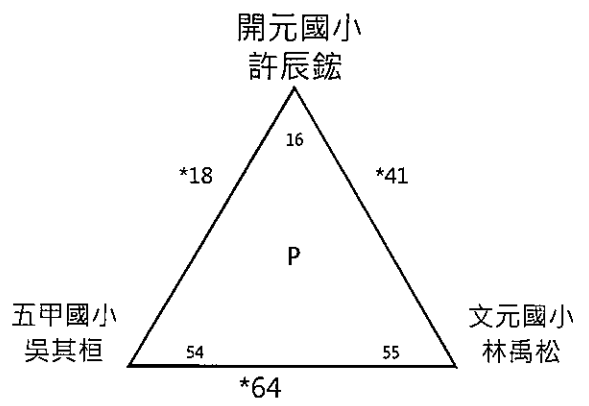
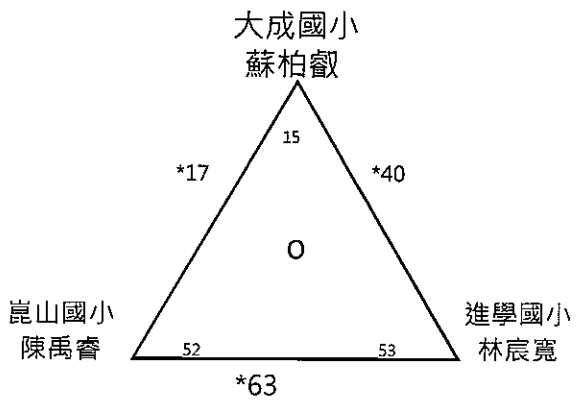
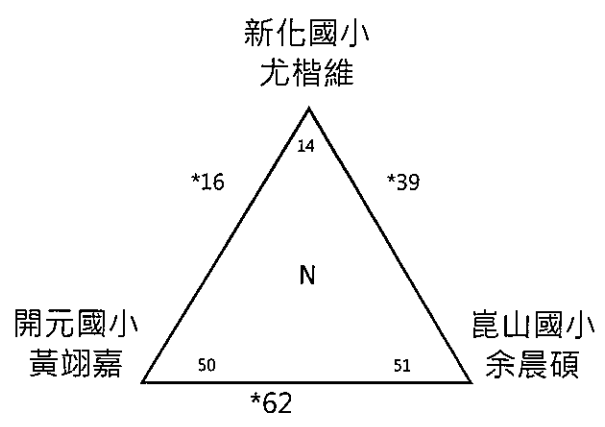
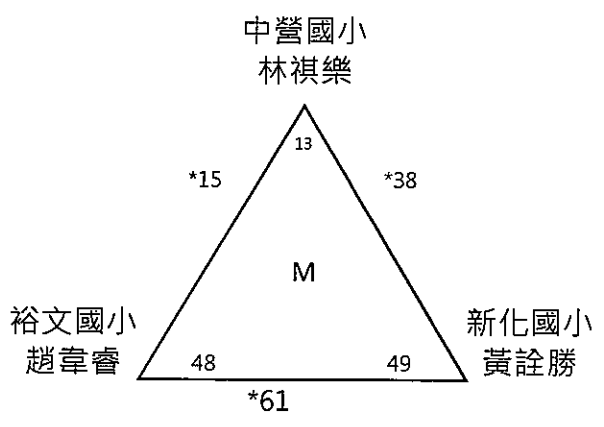
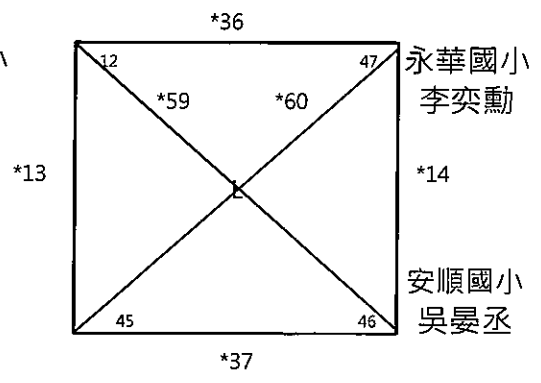
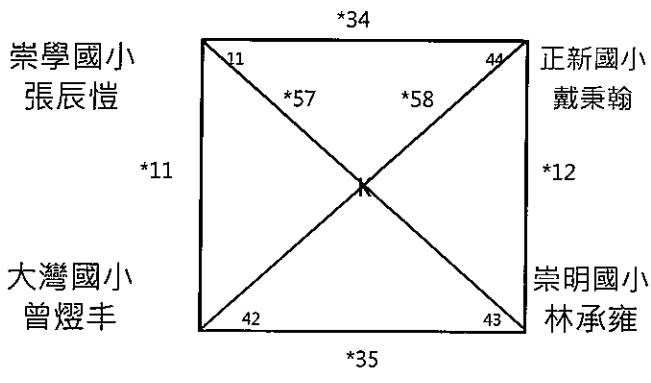
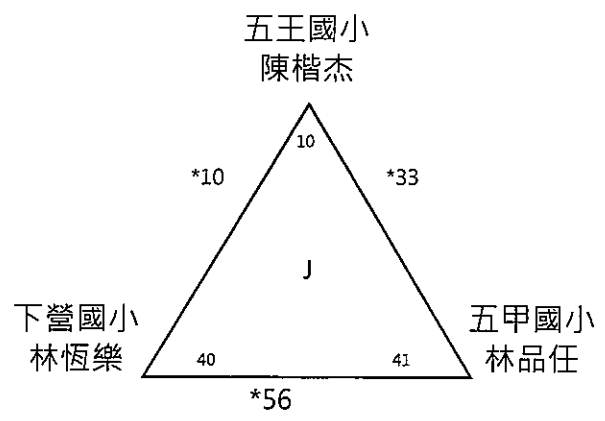
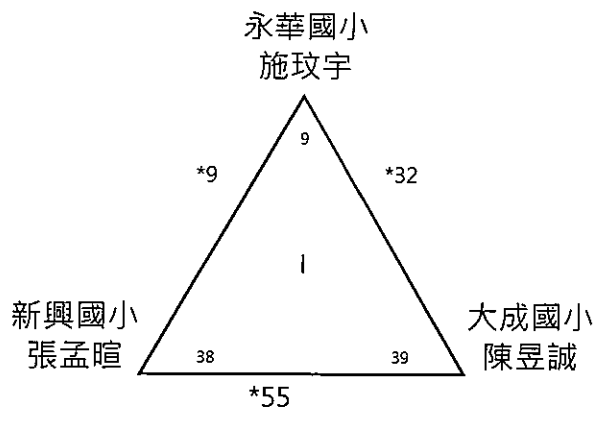

組別: 4男單 預賽

組數: 65 小組3取1、4取2

9月9日

晉級: 23

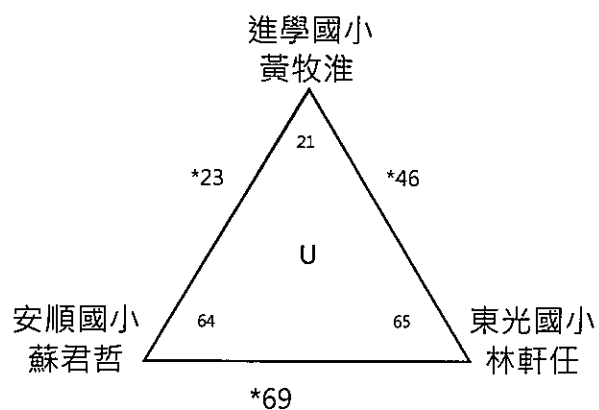
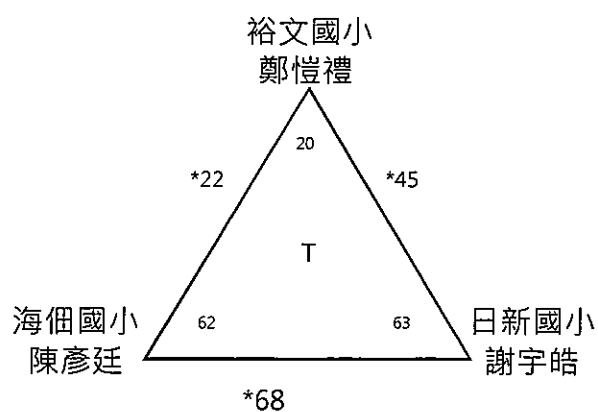
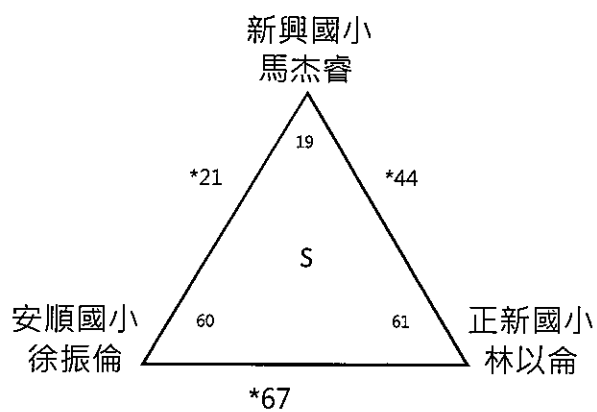
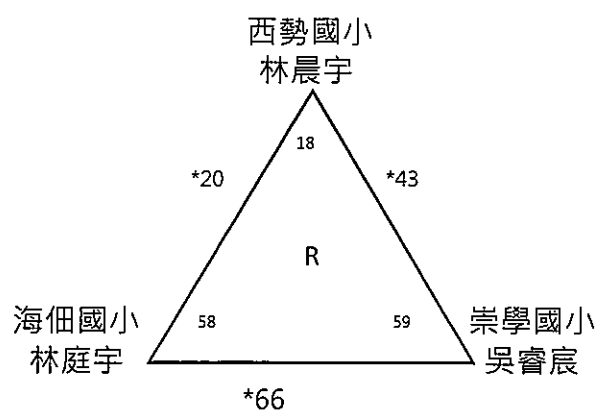
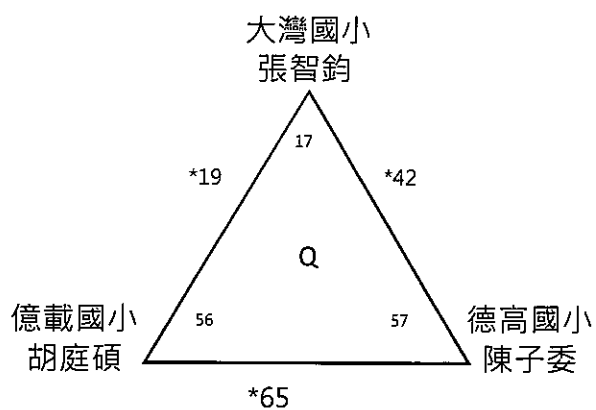

組別:4男單決
 決賽 23
 名次:取八名

9月10日

籤號

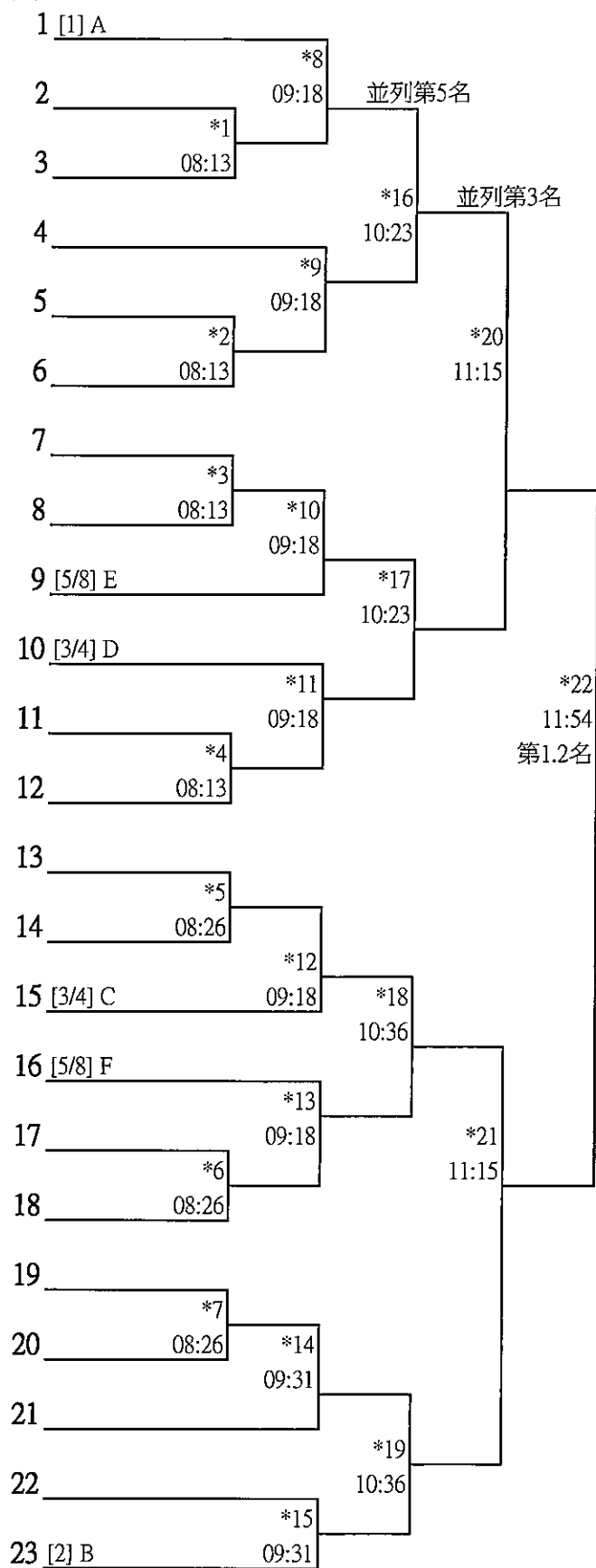

組別: 5男單 預賽
組數: 56 小組3取1、4取2
晉級: 20

9月11日

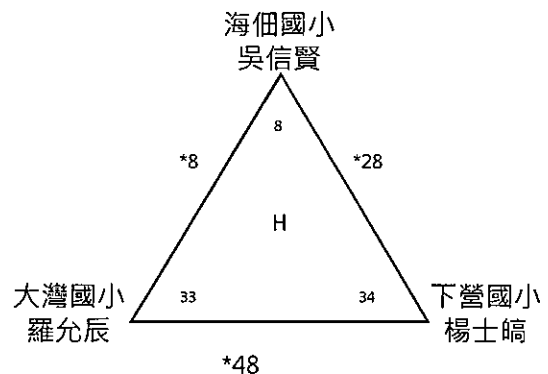
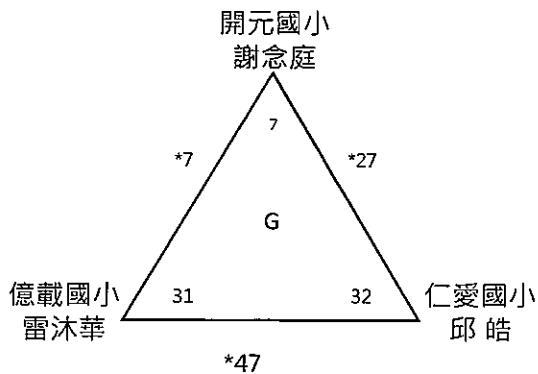
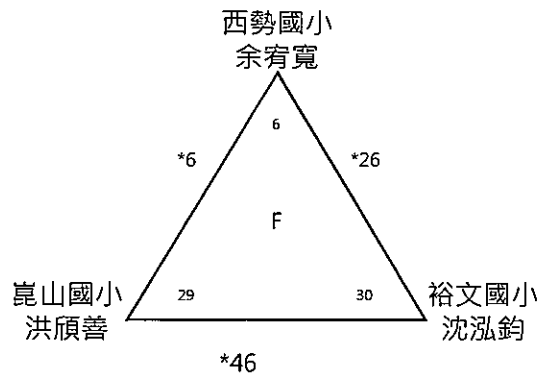
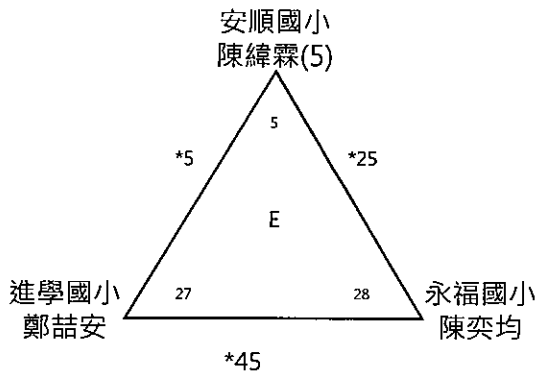
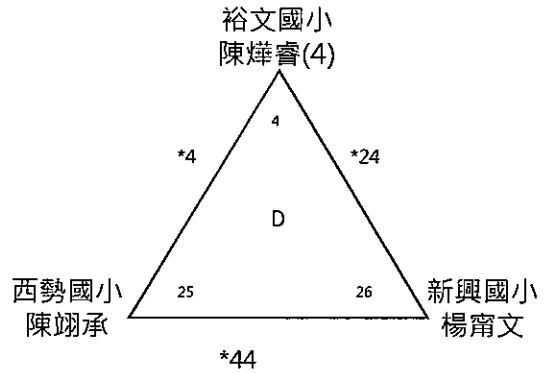
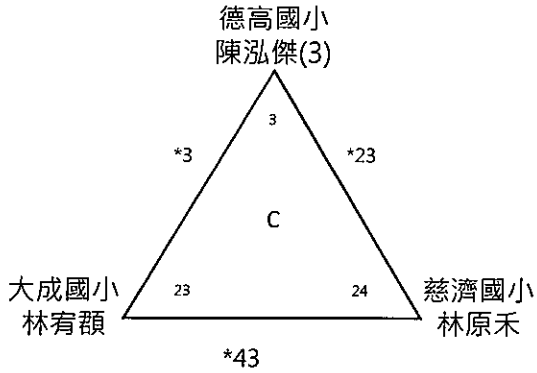
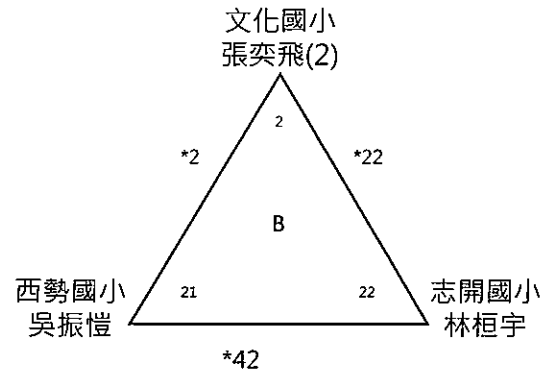
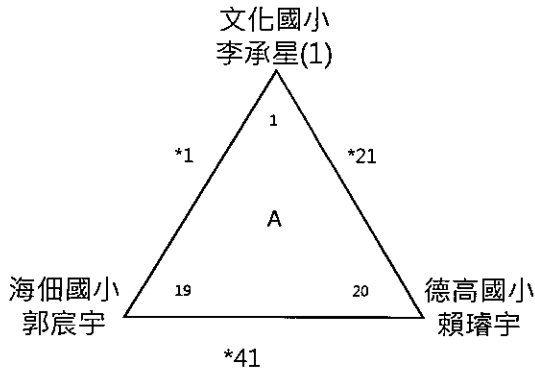

組別: 5男單 預賽
 組數: 56 小組3取1、4取2
 晉級: 20

9月11日

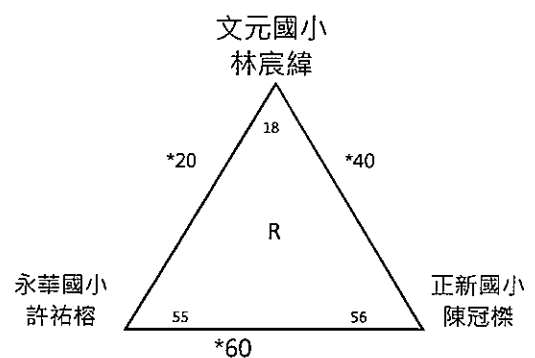
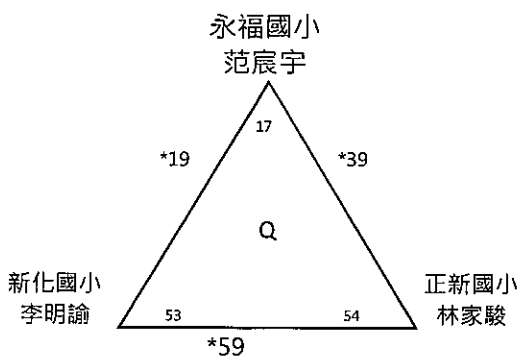
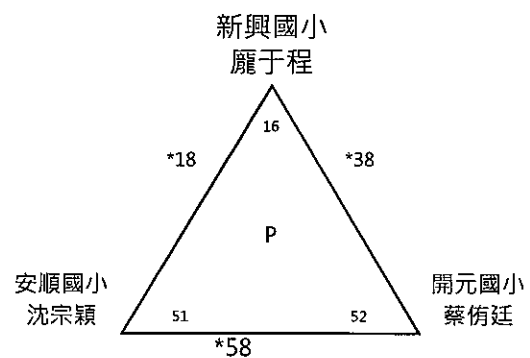
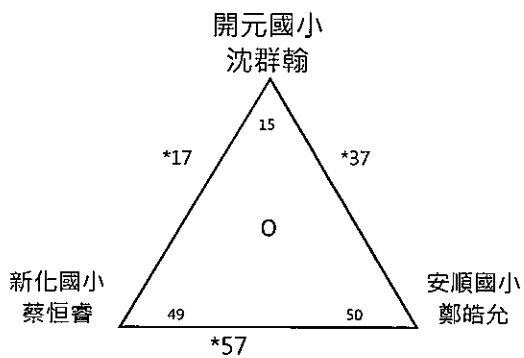
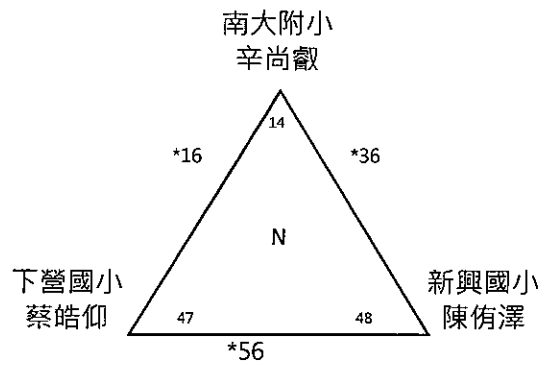
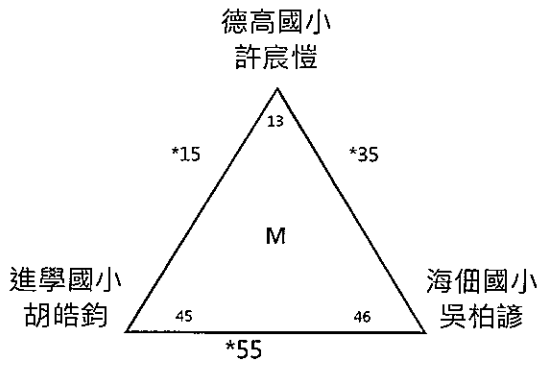
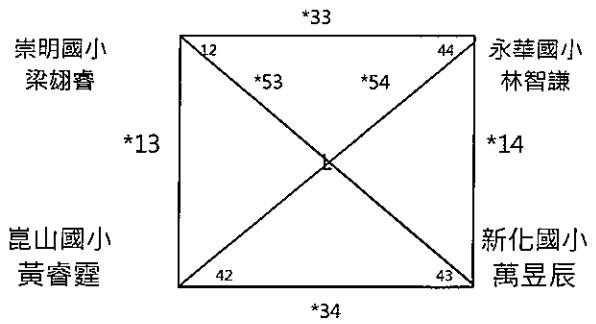
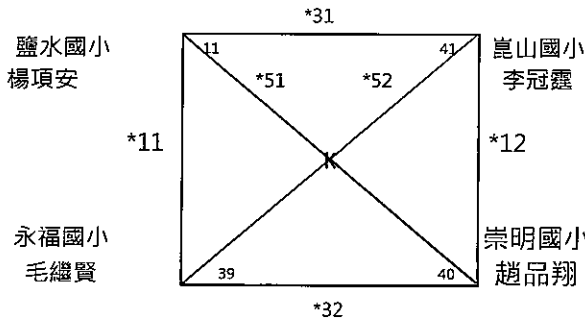
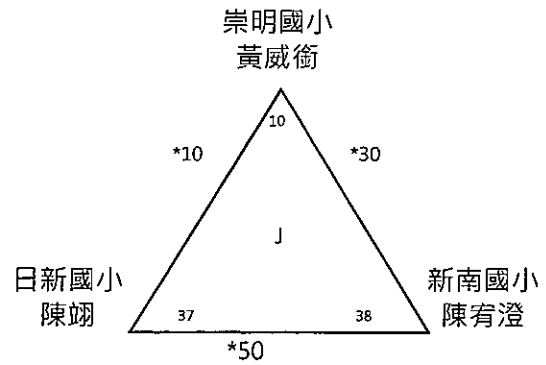
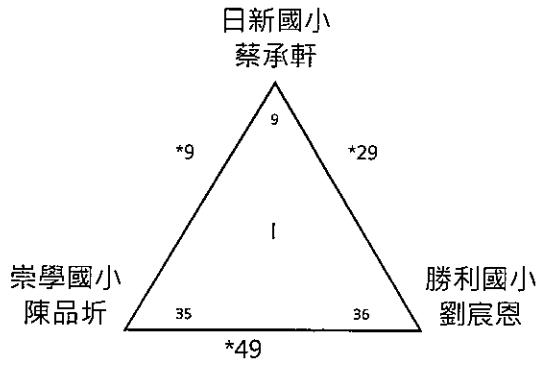

組別: 5男單決
 組數: 20
 決賽:
 名次: 取八名

9月11日

籤號 種子

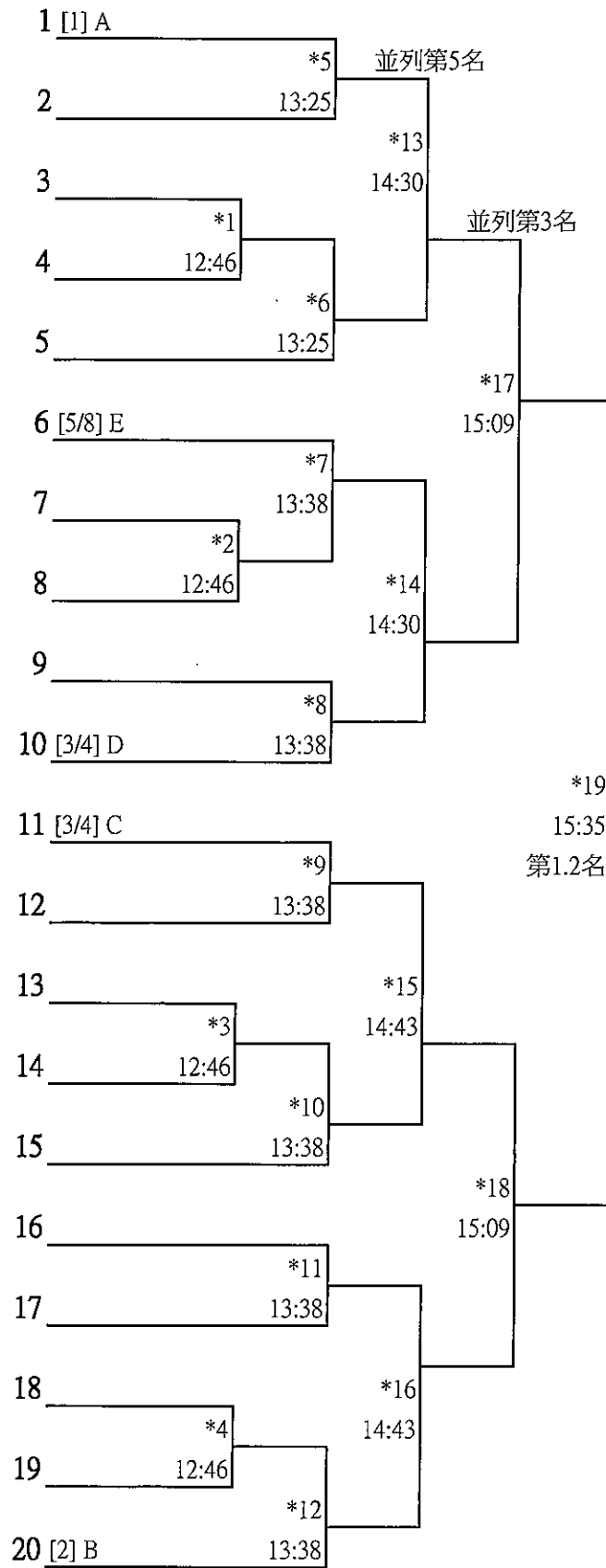

組別: 5男雙 預賽
 組數: 24 小組3取1、4取2
 晉級: 8

9月10

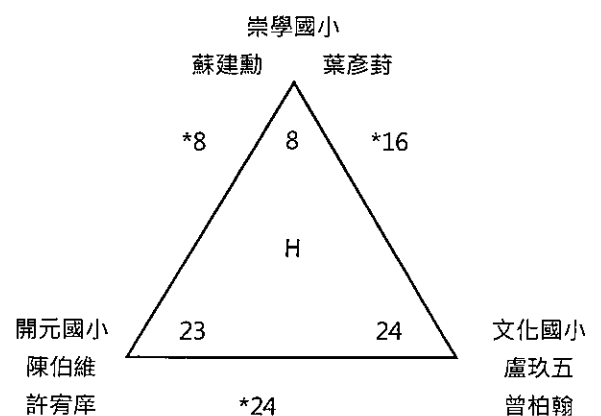
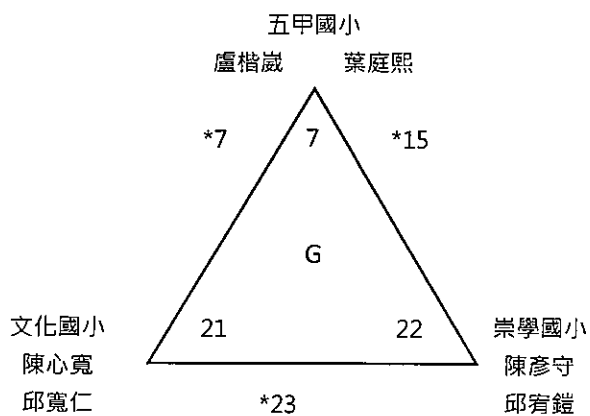
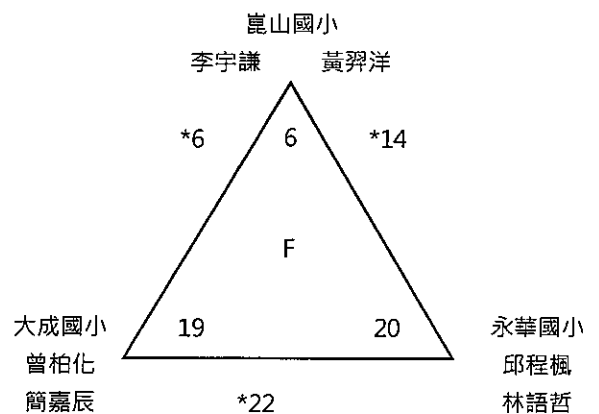
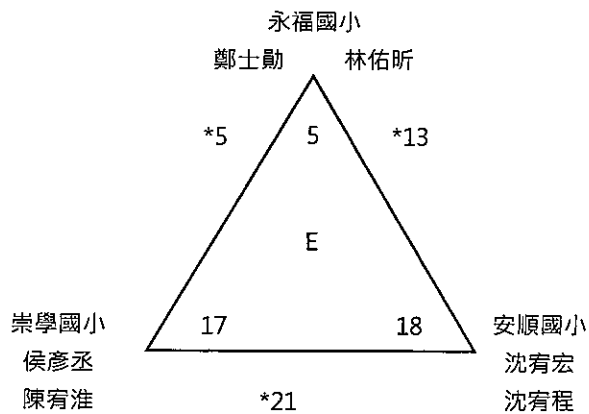
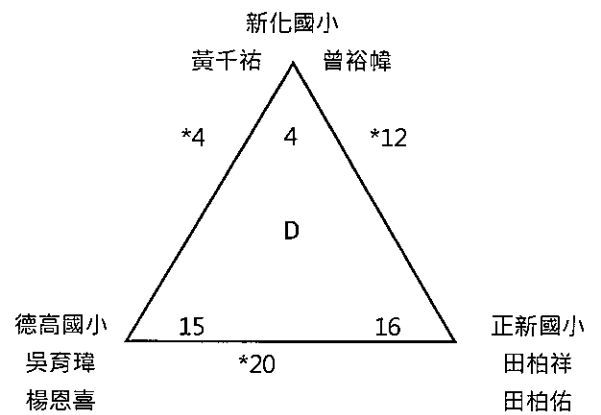
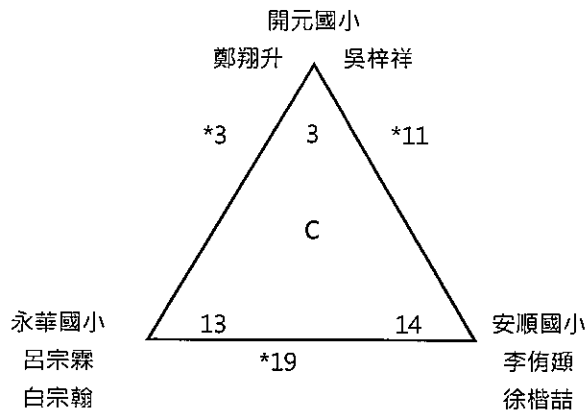
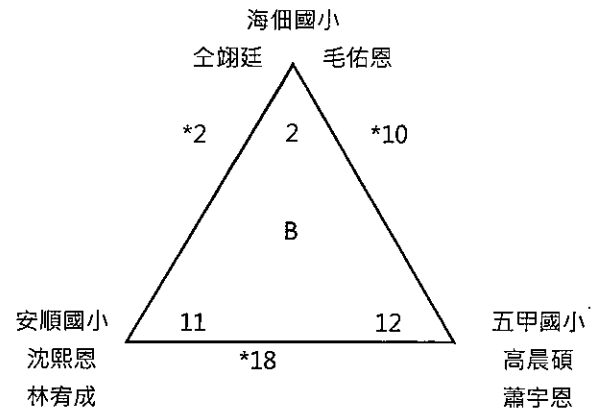
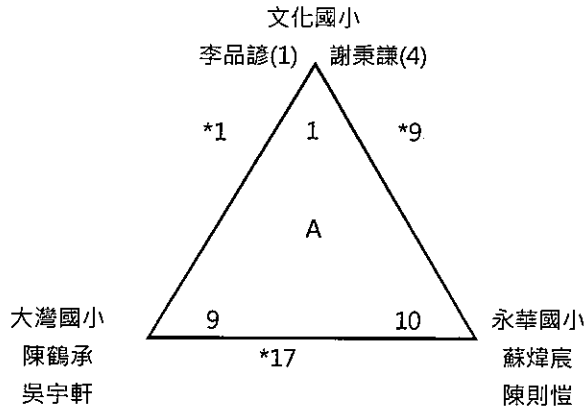

組別: 5男雙決
 組數: 8
 決賽:
 名次: 取八名

9月10日

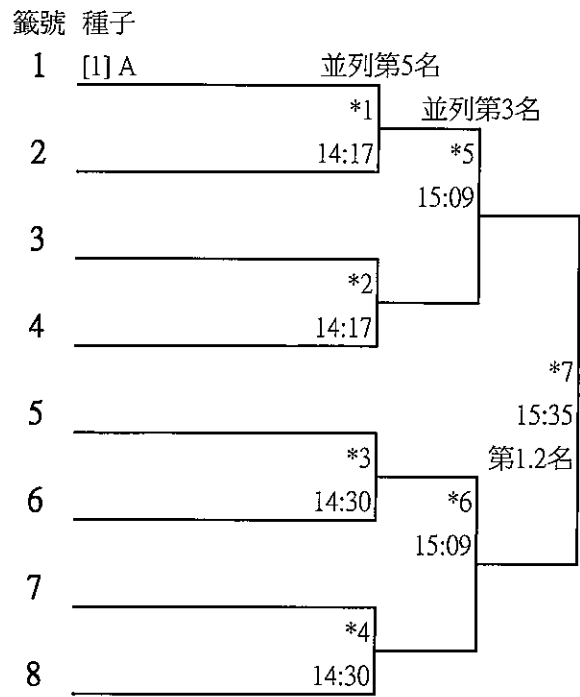

組別: 6男單 預賽
組數: 51 小組3取1、4取2
晉級: 17

9月11日

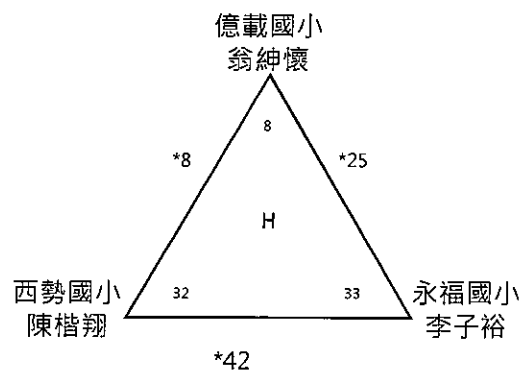
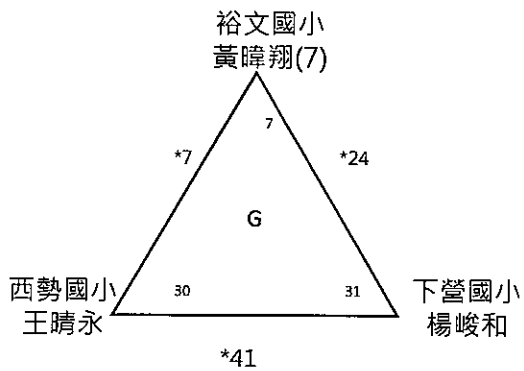
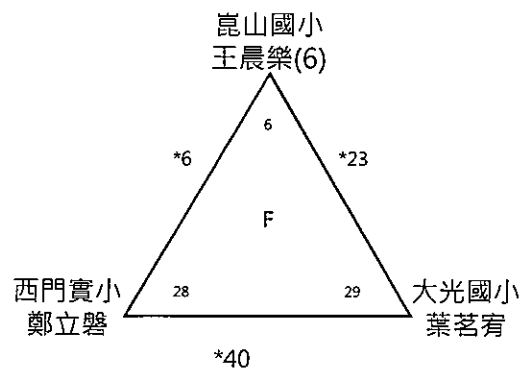
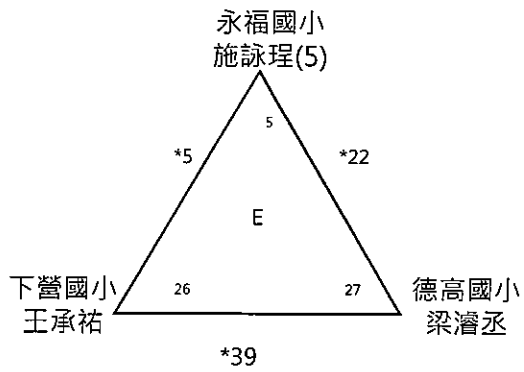
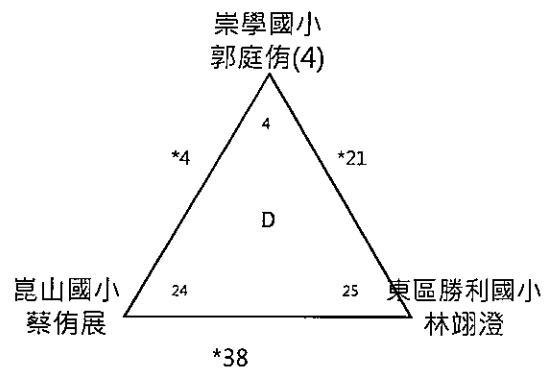
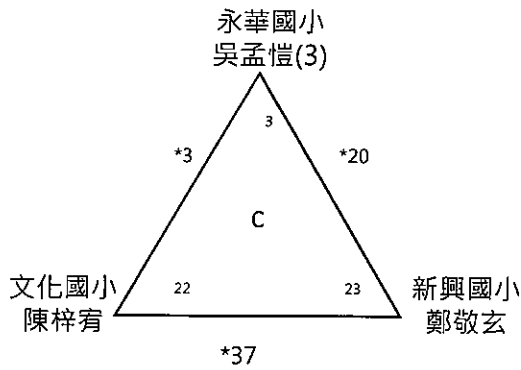
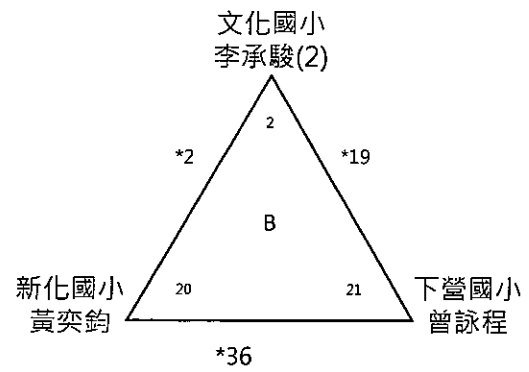
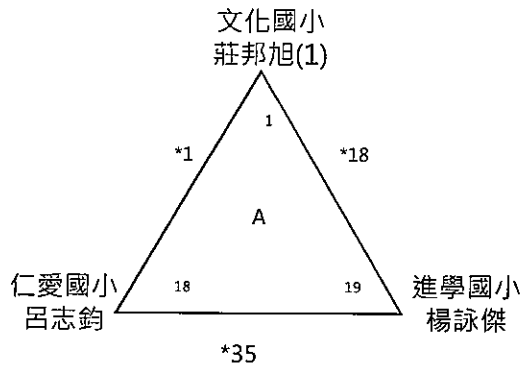

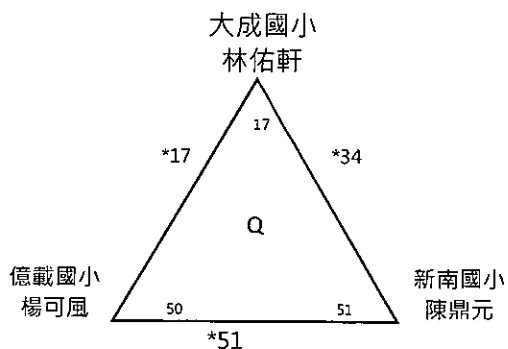
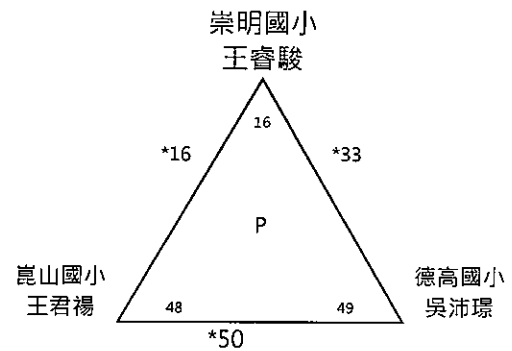
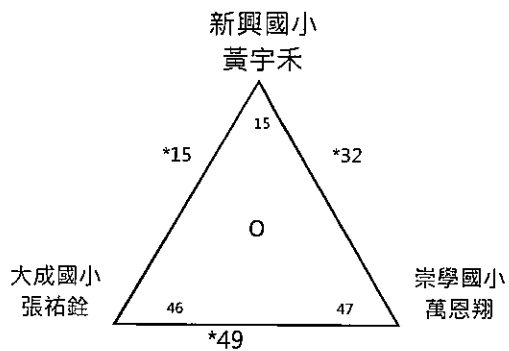
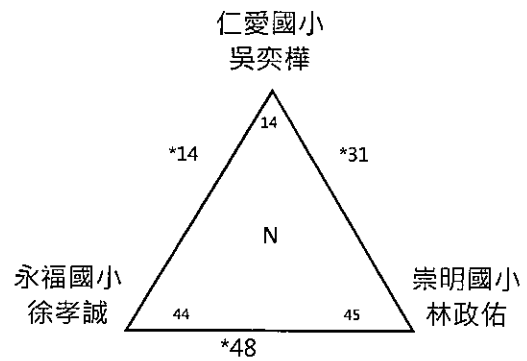
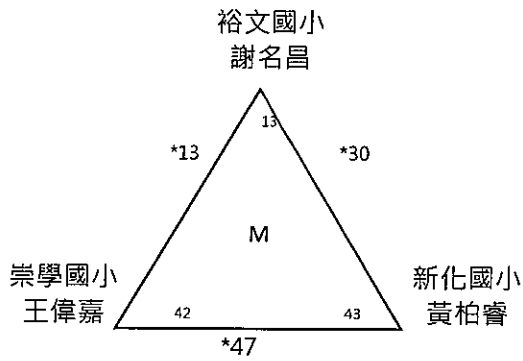
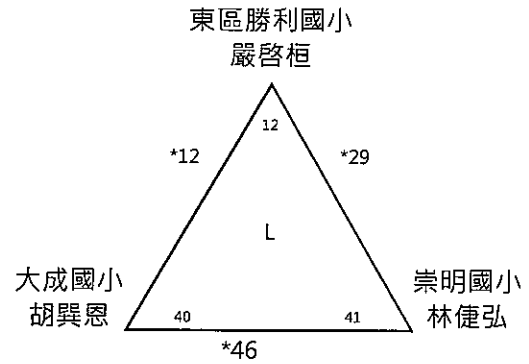
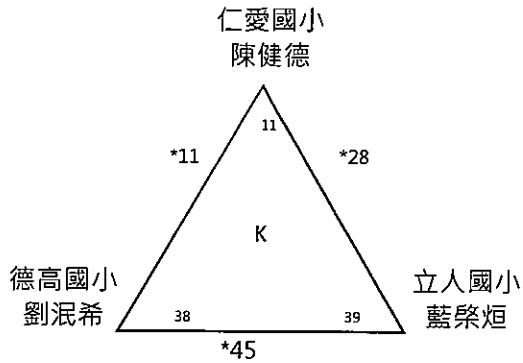
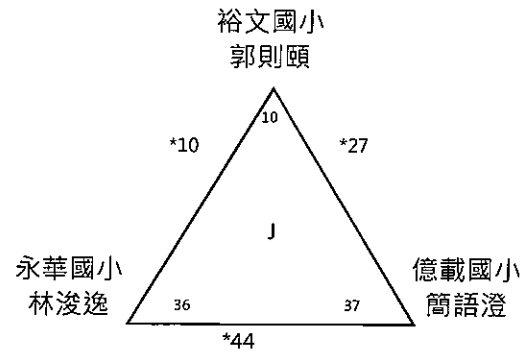
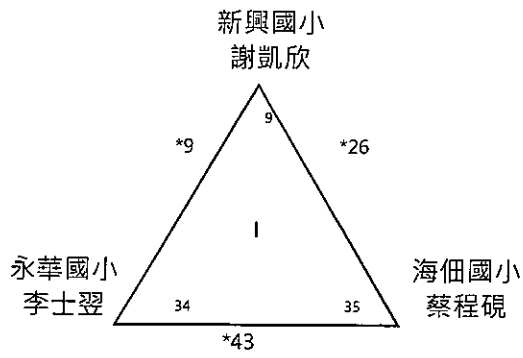

組別: 組別: 6男單決
 賽制: 組數: 17
 組數: 決賽:
 名次: 名次: 取八名

9月11日

籤號 種子

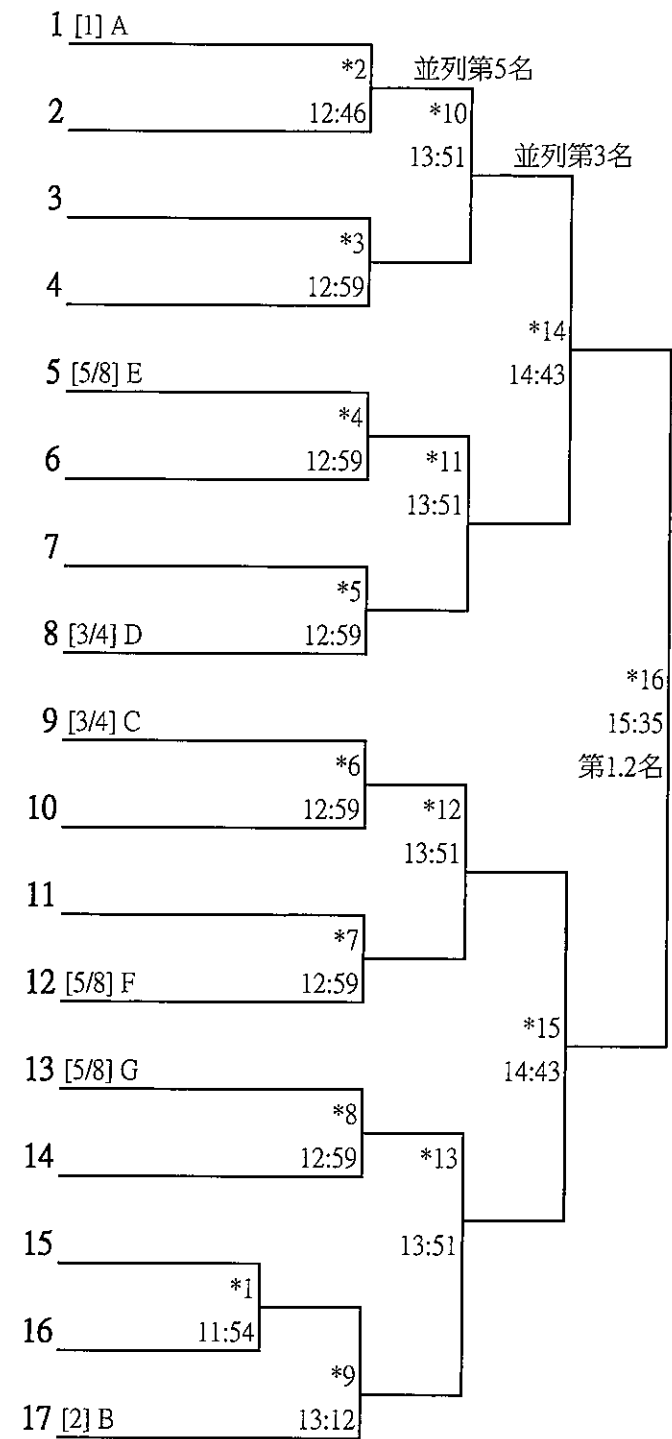

組別: 6男雙 預賽

組數: 25 小組3取1、4取2

晉級: 9

9月10日

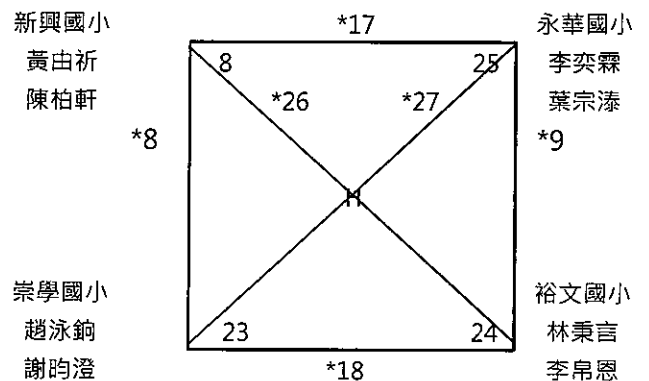
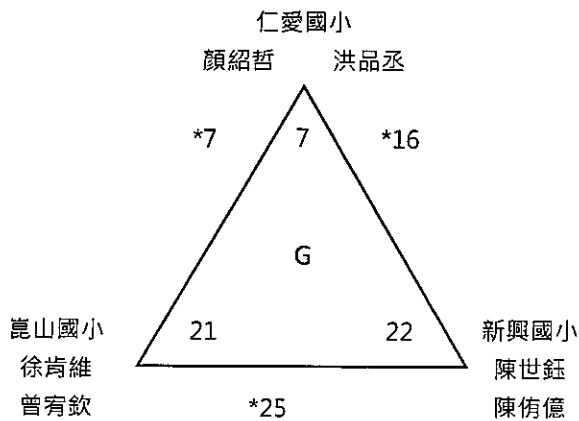
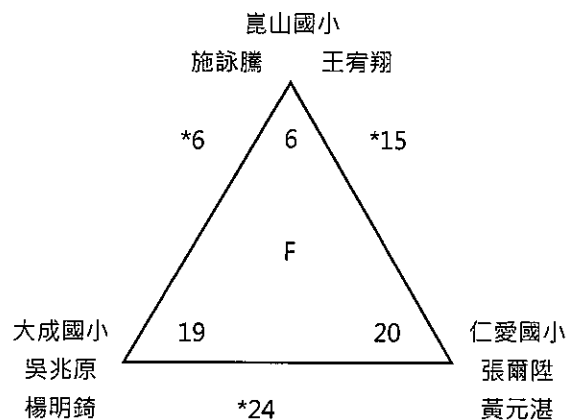
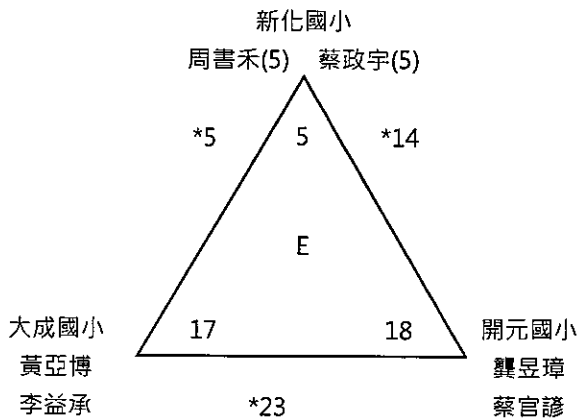
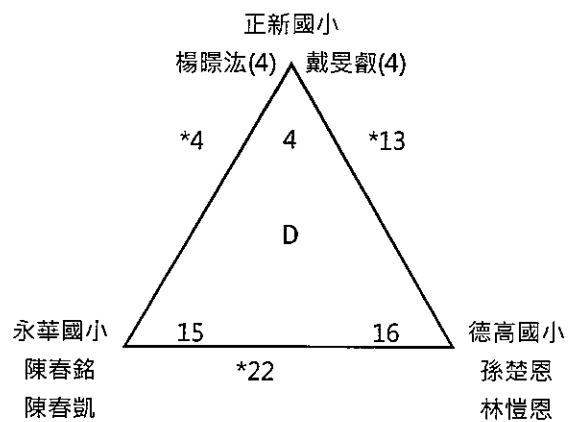
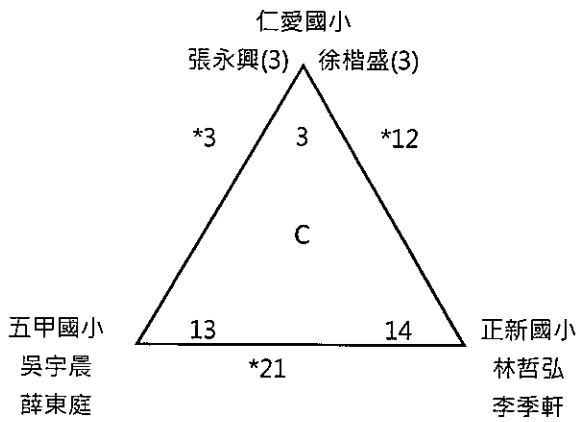
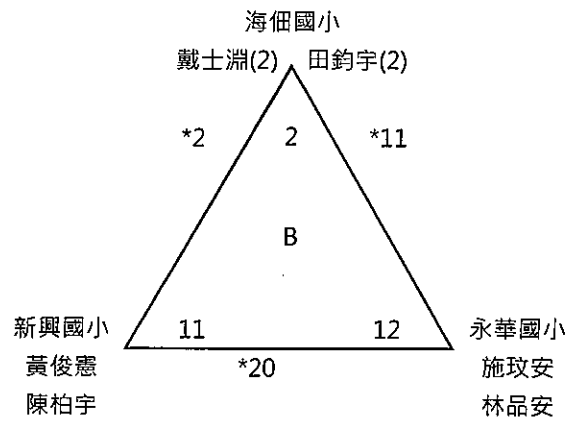
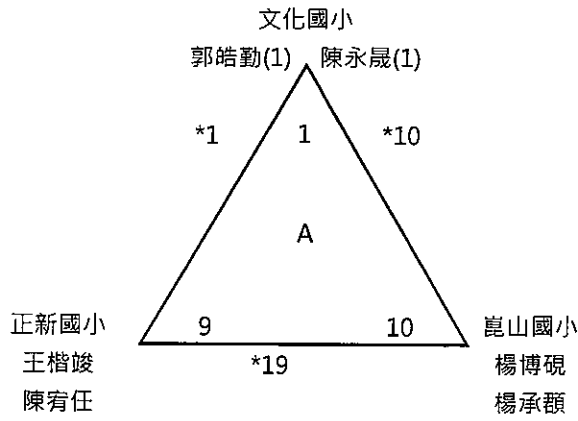

組別: 6男雙決

組數: 9

決賽:

名次: 取八名

9月11日

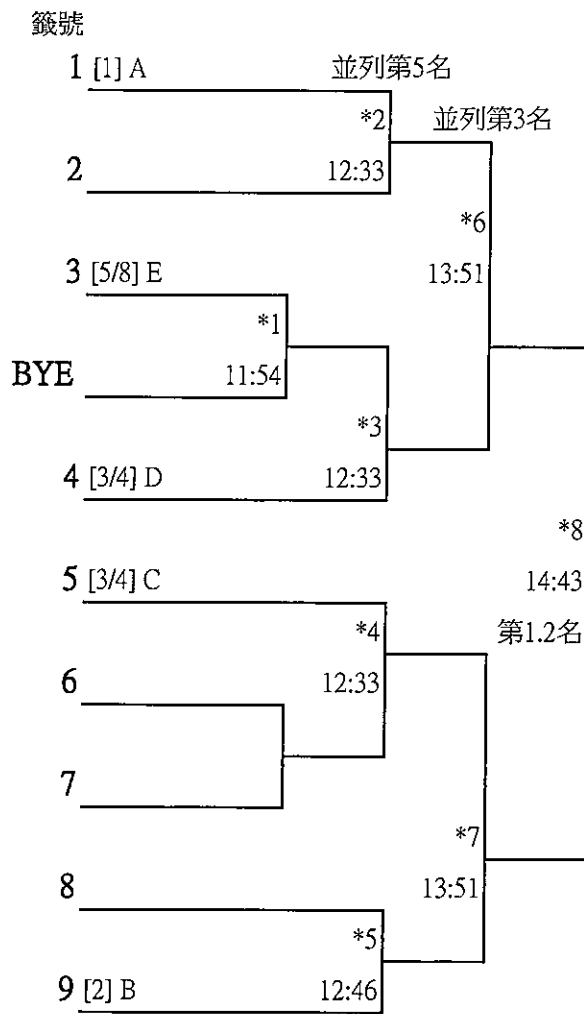

組別: 3女單 預賽

組數: 41 小組3取1、4取2

晉級: 15

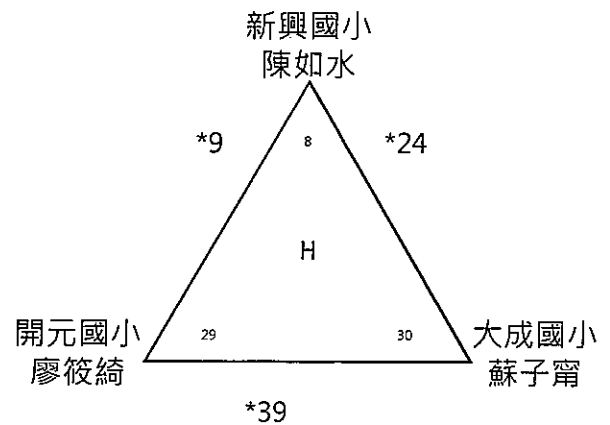
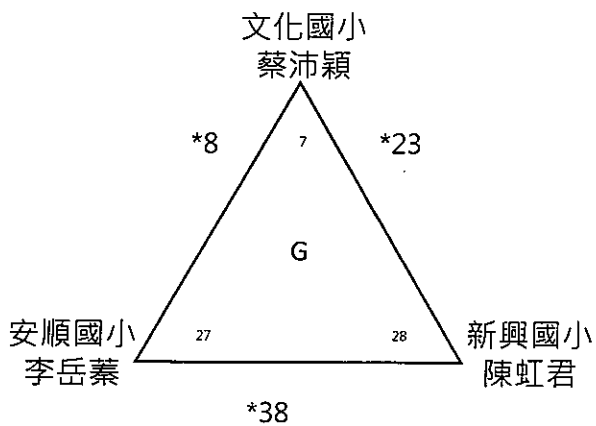
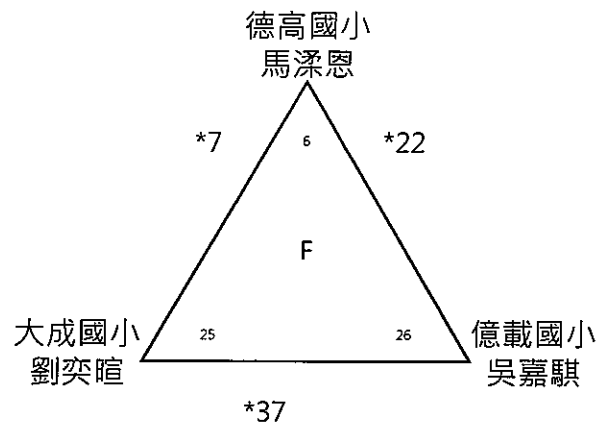
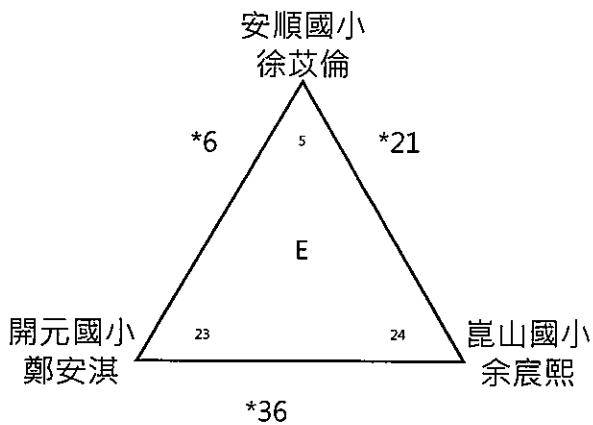
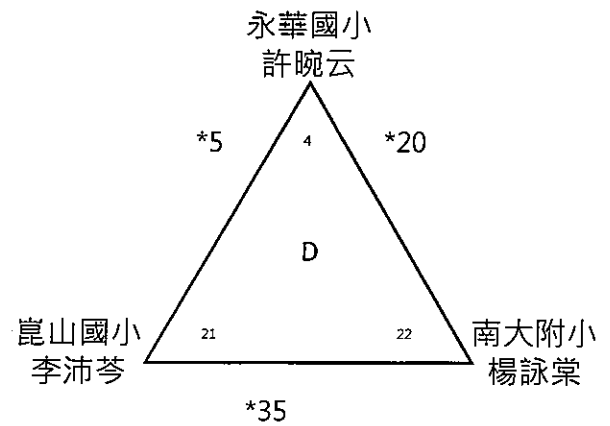
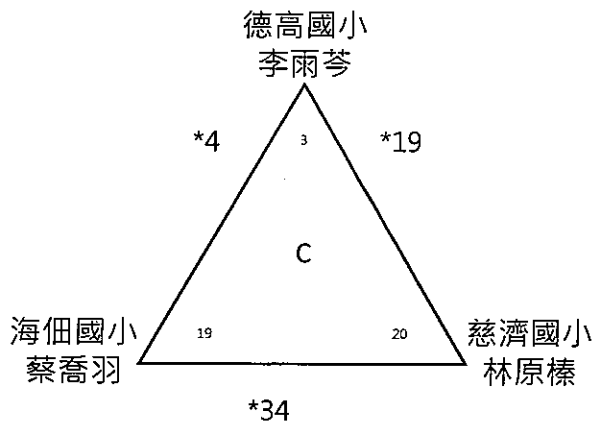
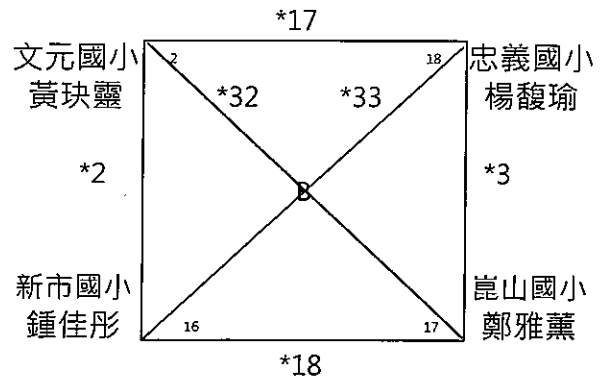
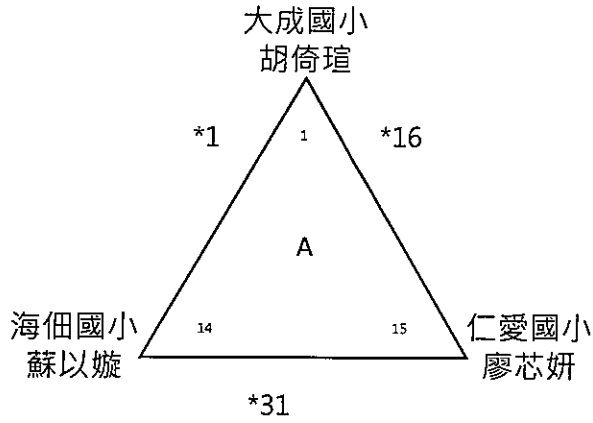

組別: 3女單
 組數: 41
 晉級: 15

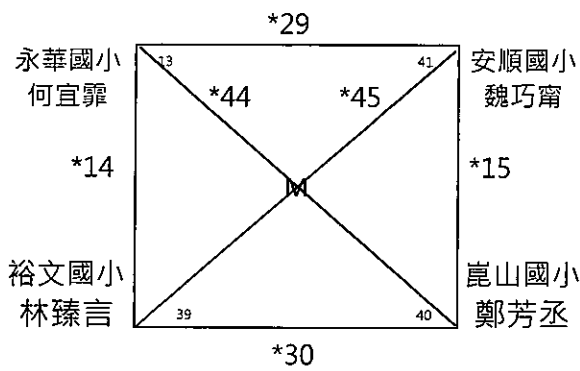
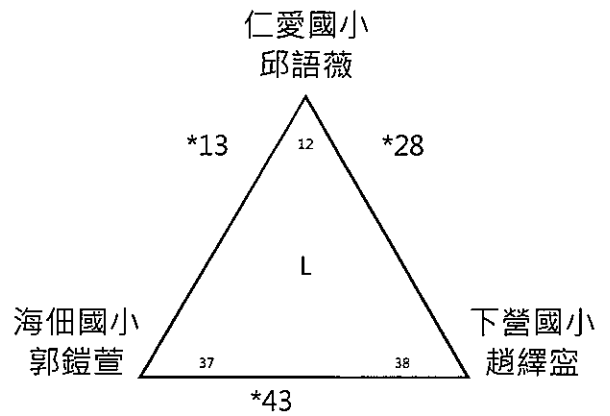
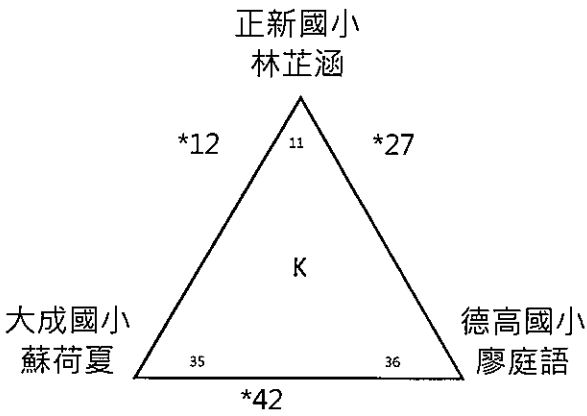
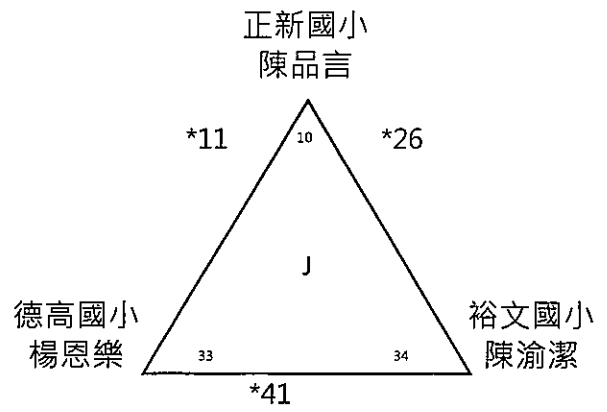
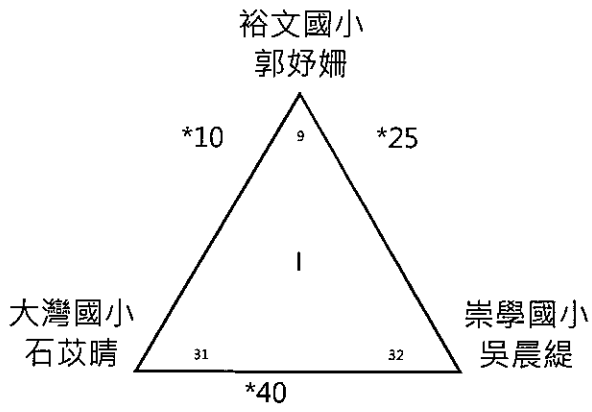

組別: 3女單決
 組數: 15
 決賽:
 名次: 取八名

9月9日

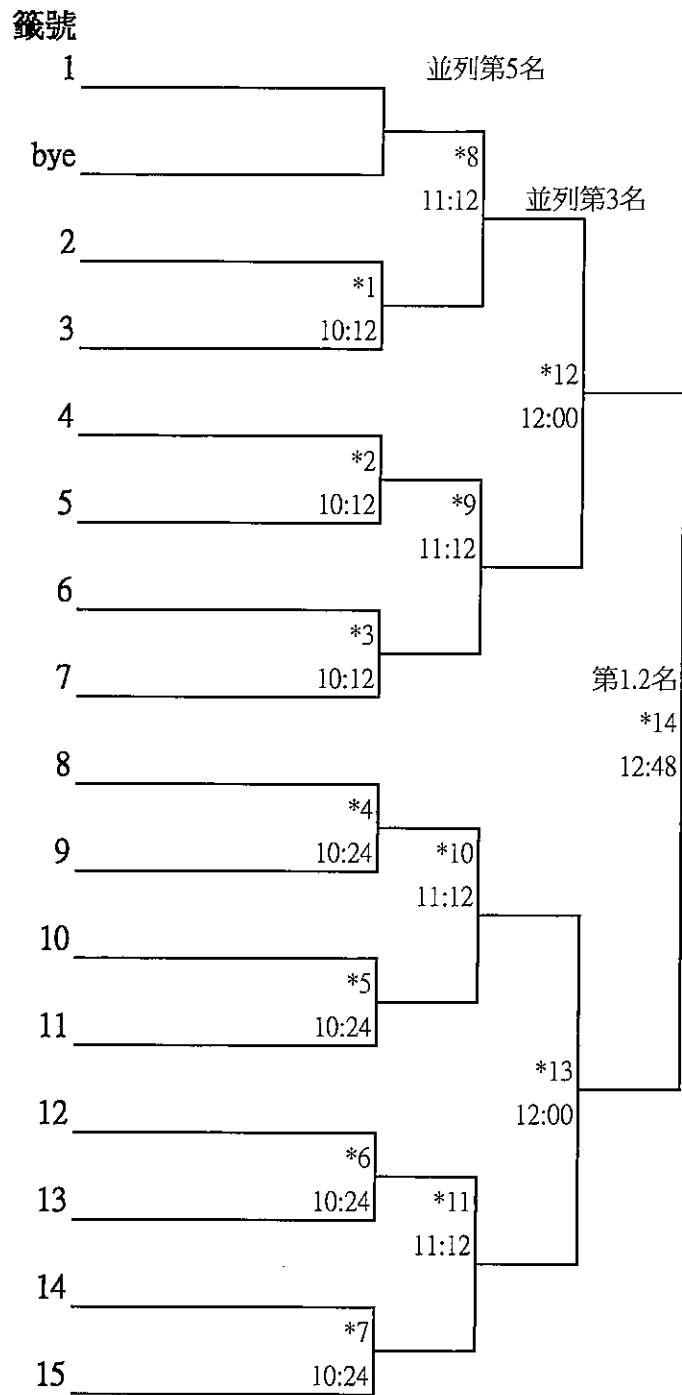

組別: 4女單 預賽
 組數: 32 小組3取1、4取2
 晉級: 12

9月9日

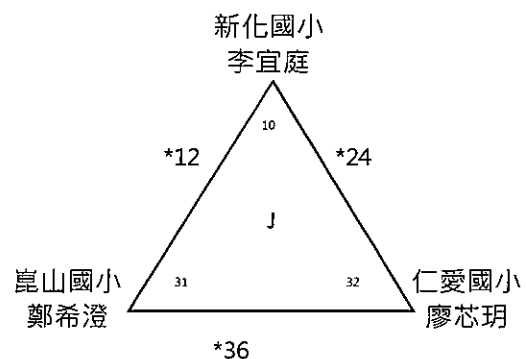
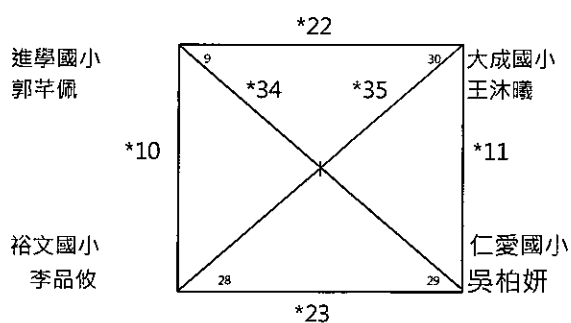
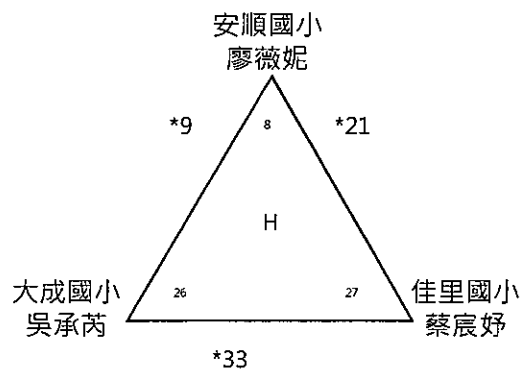
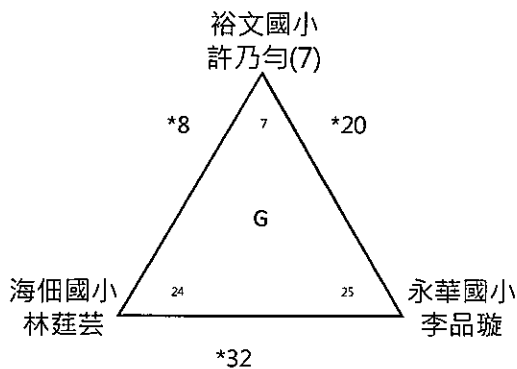
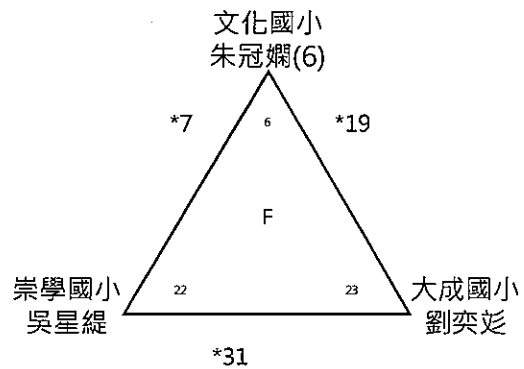
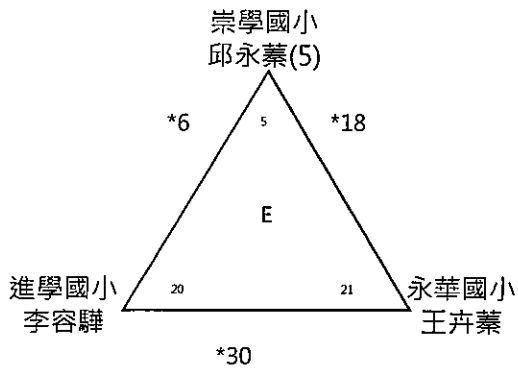
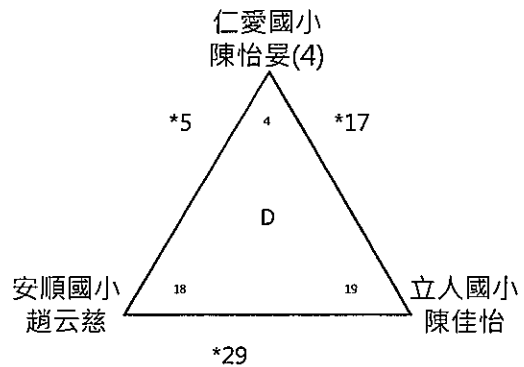
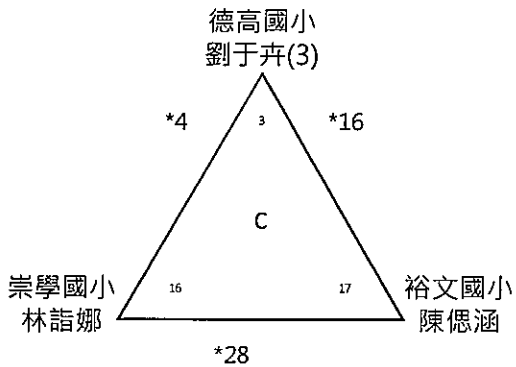
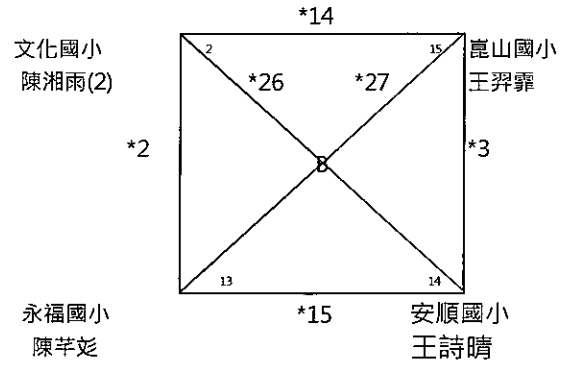
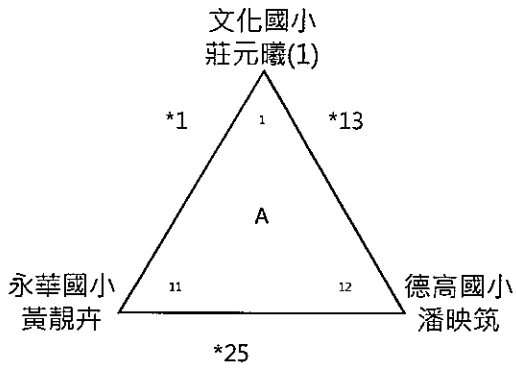

組別: 4女單決
 組數: 12
 決賽:
 名次: 取八名

9月10日

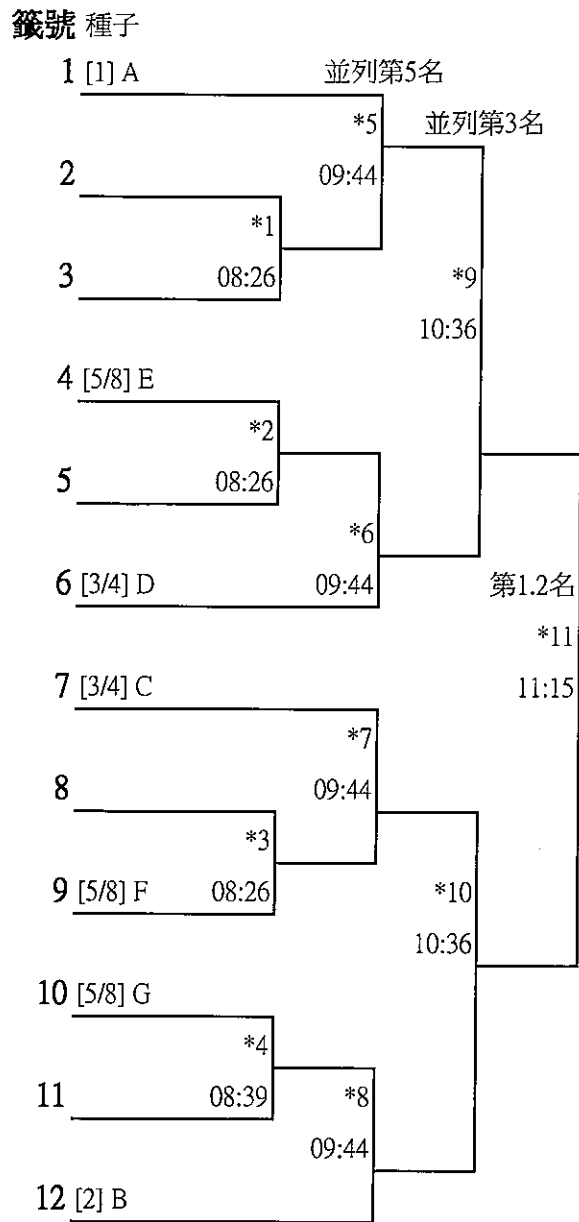

組別: 5女單 23組,取8名 賽制:雙敗淘汰制
 勝部: 9月10日

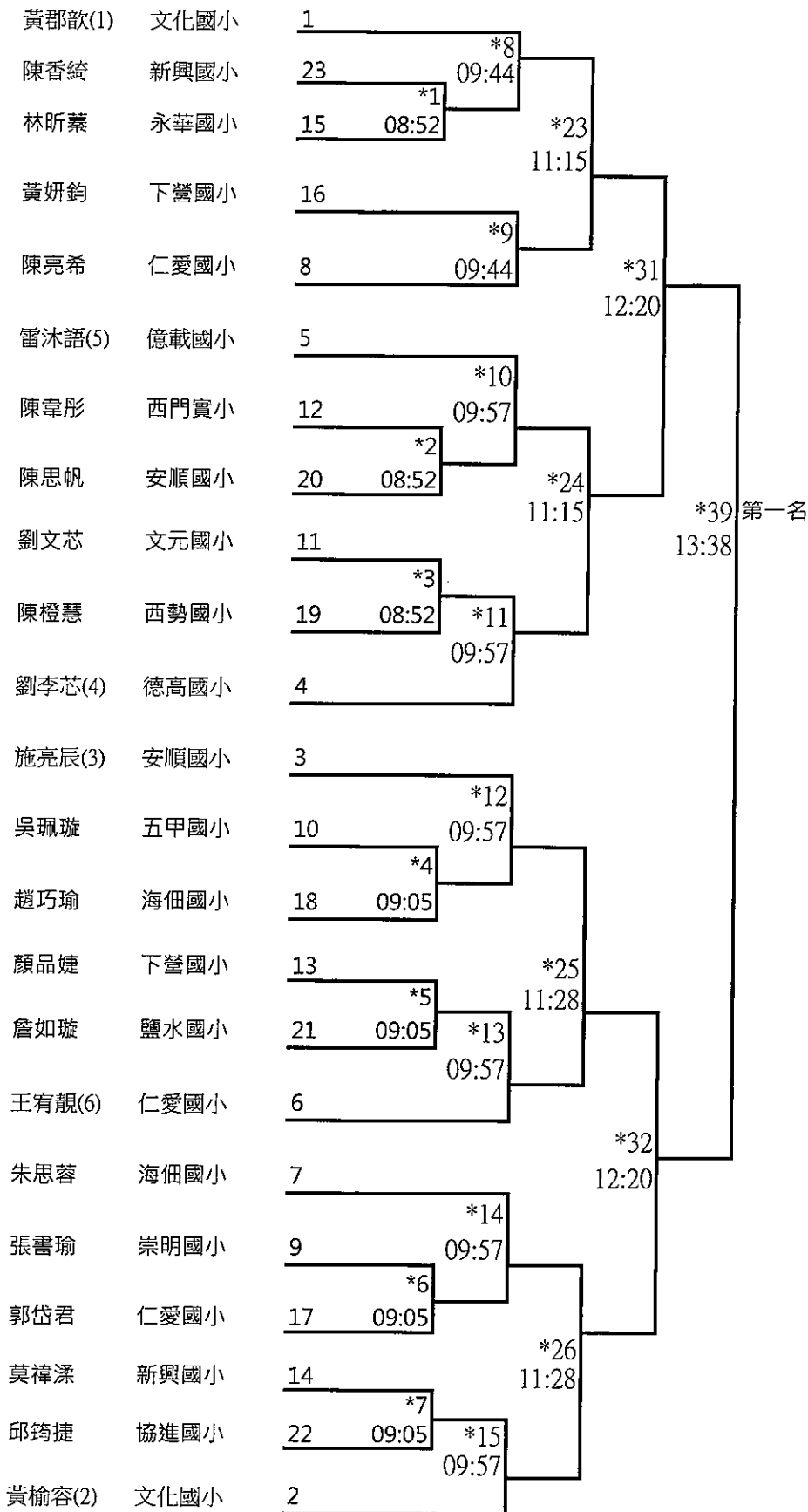

組別: 5女單

23組,取8名

賽制:雙敗淘汰制

敗部:

9月10日

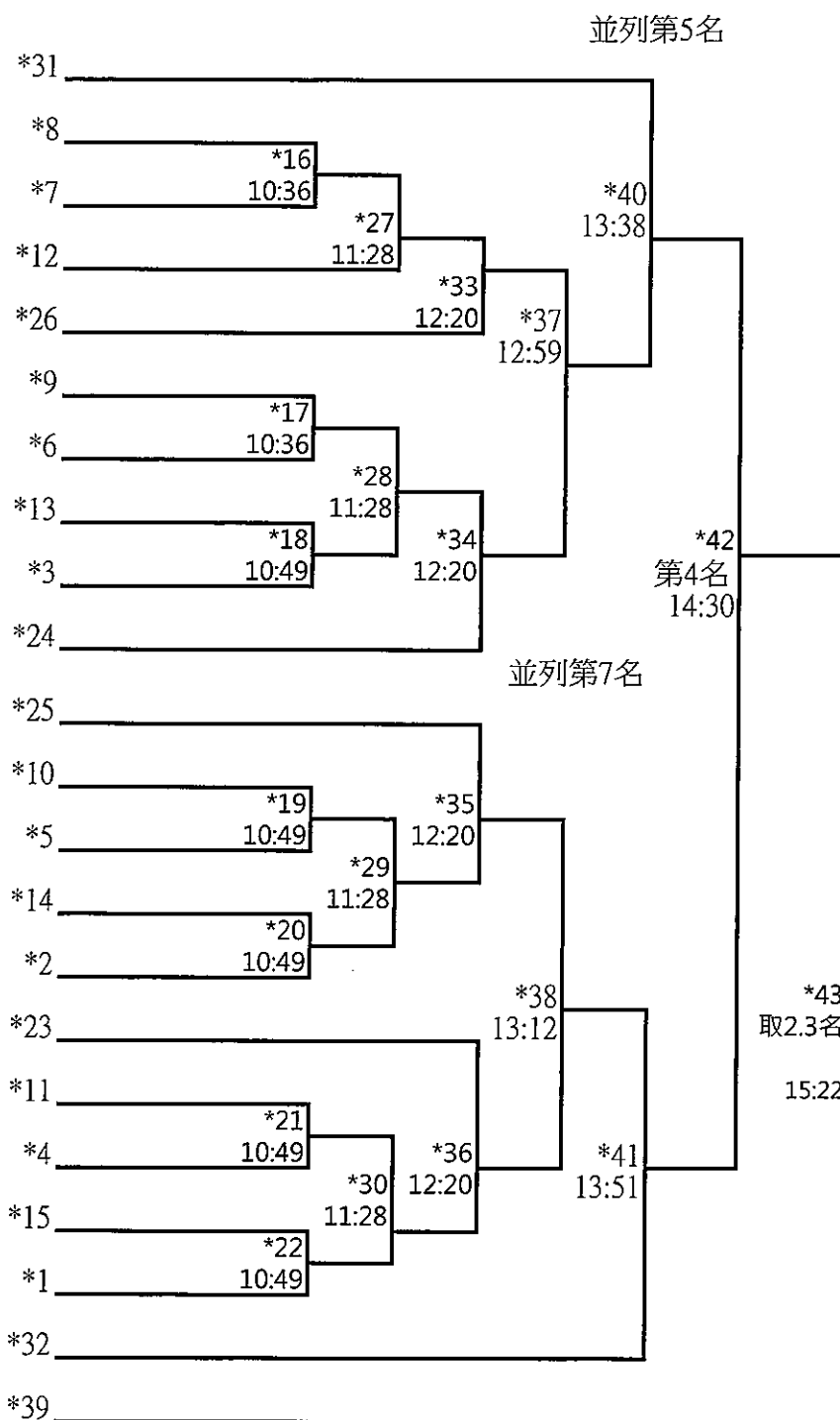

組別: 5女雙 6組,取4名

賽制:雙敗淘汰制

勝部:

9月10日

朱妍霓(1) 張芷綺(1) 文化國小

1

蔡芯耘 林楨 新化國小

5

詹唯 黃善美 崇學國小

4

江品妍 方紀薇 仁愛國小

3

蔡辰暄 蔡辰晞 億載國小

6

蔡羽卉 郭香伶 文化國小

2

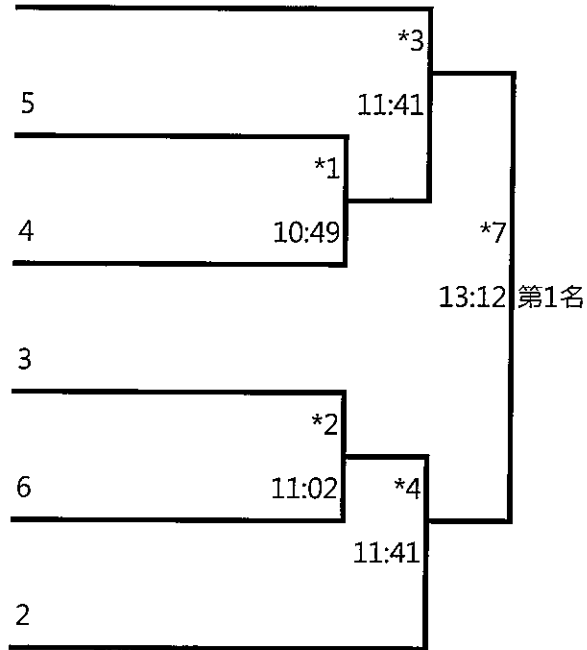

敗部:

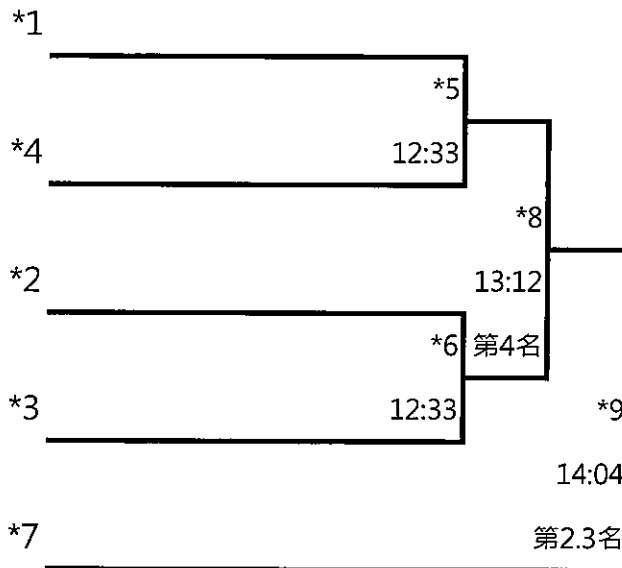

組別: 6女單 18組,取8名

賽制:雙敗淘汰制

勝部:

9月10日

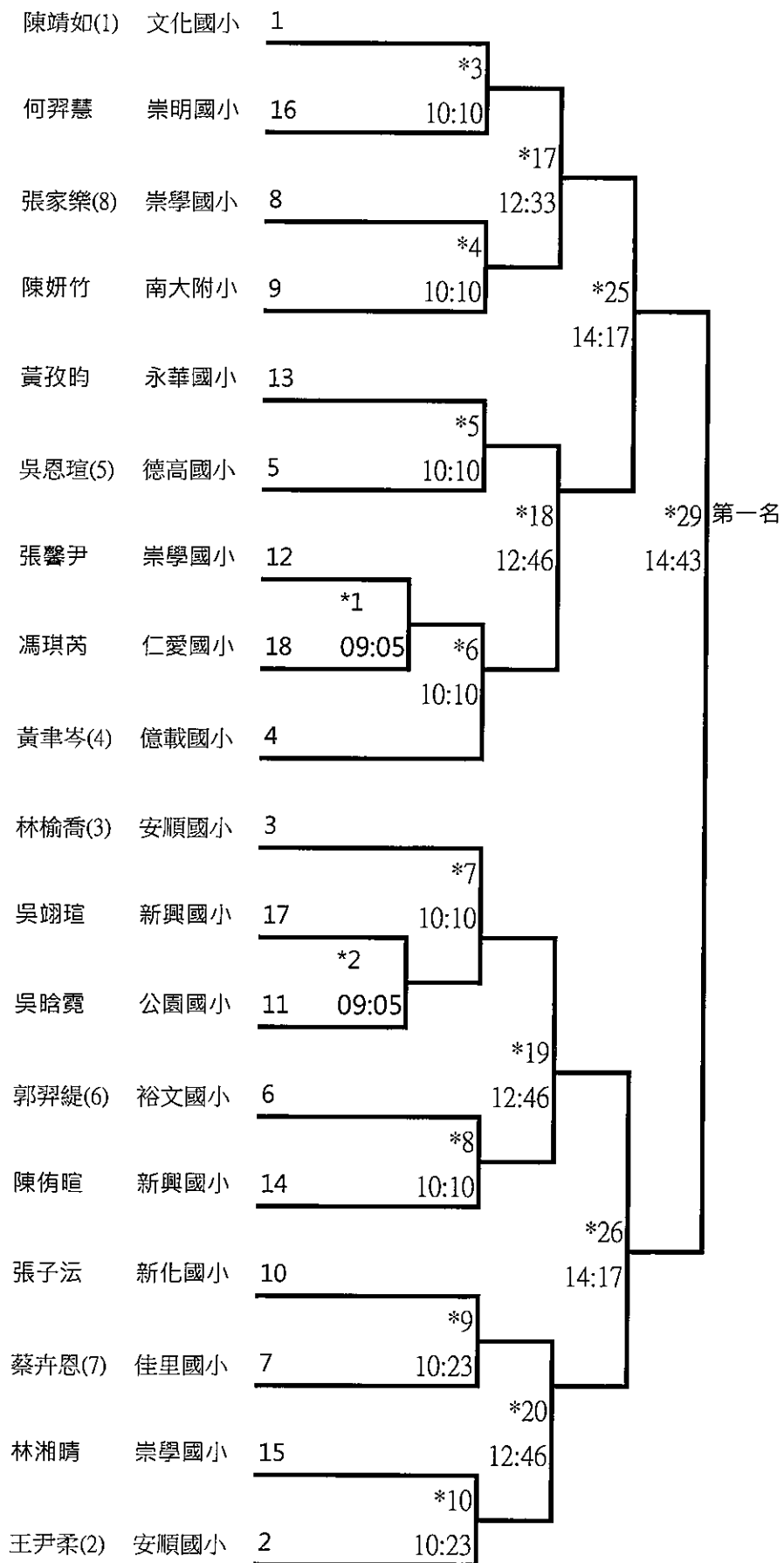

組別: 6女單 18組,取8名

敗部:

9月10日

並列第5名

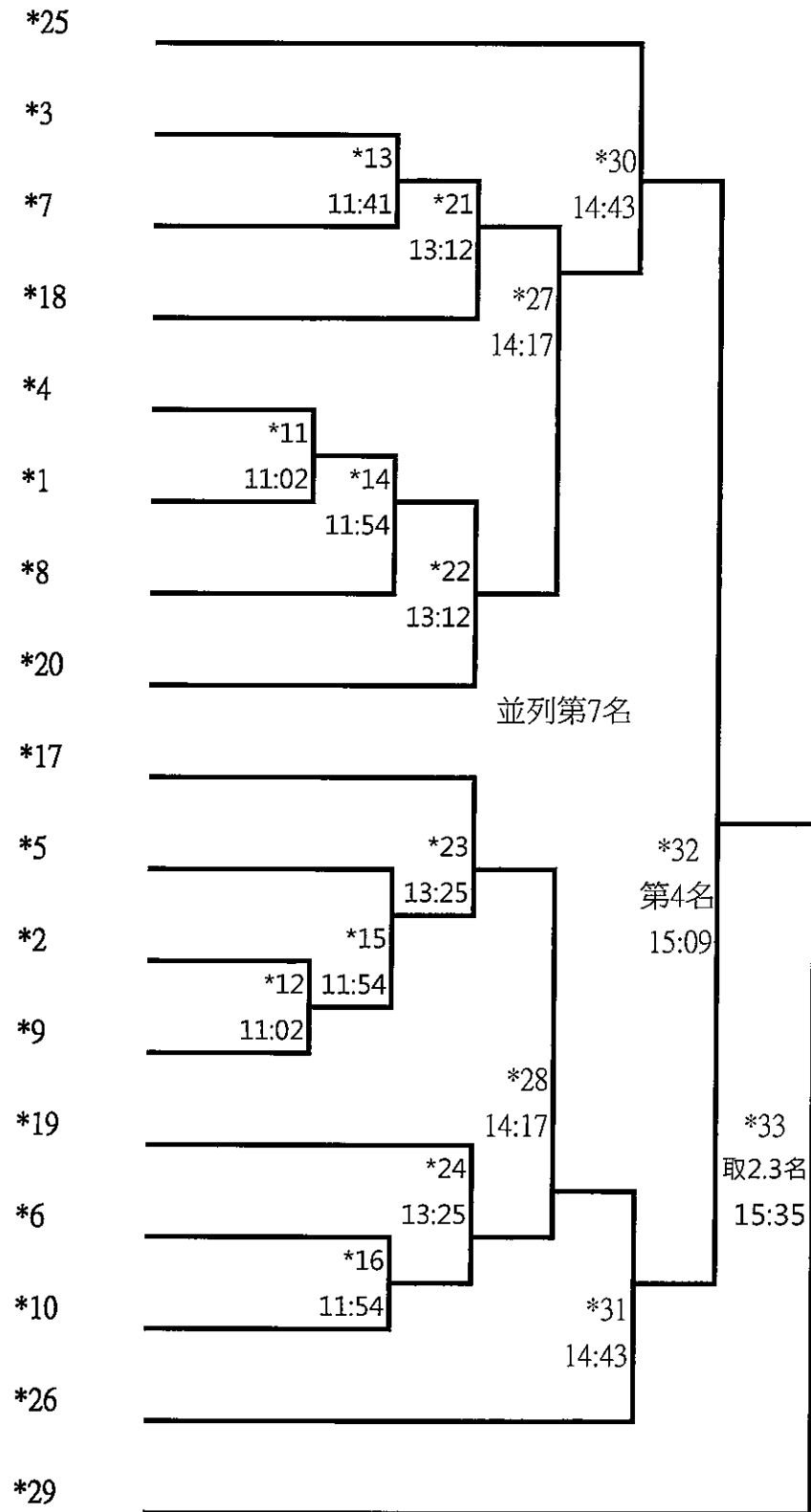

組別: 6女雙 7組,取5名

賽制:雙敗淘汰制

勝部:

9月10日

方楷晴	何羽彤(1)	龍崎國小
曾珮晴	許語暉(5)	大成國小
呂依橙	林楷宸(4)	開元國小
曾歆恬	李享芸(3)	大成國小
李書妍	許芩嘉	崑山國小
郭芃妤	吳旻宣	五甲國小
王上涵	吳芳誼(2)	海佃國小

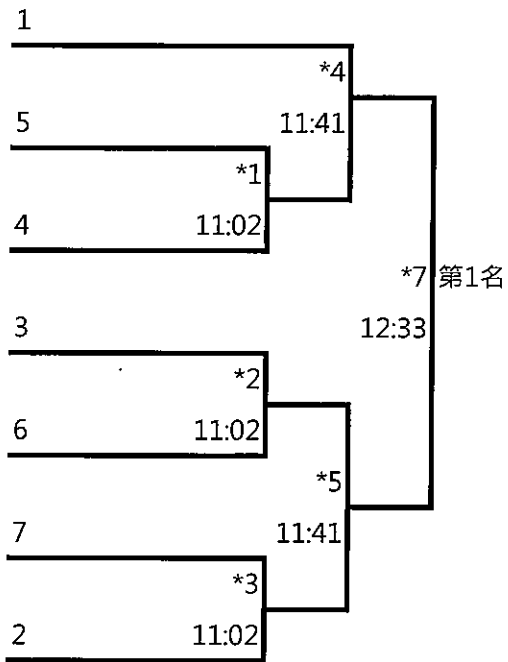

敗部:

